



**Multi-CD/MD/DAB control High power CD player
with RDS tuner**

Manual

DEH-P8100R

Pioneer

Installation	4	Basic Operation of Built-in CD Player	26
Installation with the Rubber Bush	4	• Switching the Display	
Removing the Unit	5	• Eject	
Installing the Steering Remote Control Unit	6	• Switching the Display (only for CD TEXT Discs)	
Installing the Unit on a Left-Hand-Drive Car	7	• Track Search and Fast Forward/Reverse	
Connecting the Units	8	• Disc Loading Slot	
Connection Diagram	10	• Open	
RFP Alert Installation	12	Basic Operation of Multi-CD Player	28
Description	12	• Switching the Display	
Door Switches	12	• Track Search and Fast Forward/Reverse	
DOOR SWITCH (White/yellow)	13	• Disc Search	
• Grounding Type Switch		• Switching the Display (When playing a CD TEXT disc on a CD TEXT compatible Multi-CD player)	
• Positive (Non-grounding) Type Switch		• Disc Number Search (for 6-Disc, 12-Disc types)	
• Installing New Pin Switches		• Disc Number Rough Search (for 50-Disc type only)	
Key Finder	15	Corresponding Display Indications and Buttons	30
• Head Unit		Entering the Function Menu	31
• Steering Remote Controller		Function Menu Functions	32
Before Using This Product	16	Entering the Detailed Setting Menu	34
About This Product	16	Detailed Setting Menu Functions	35
About This Manual	16	Tuner Operation	36
Resetting the Microprocessor	16	• Local Seek Tuning (LOCAL)	
About the Demo Mode	17	• Best Stations Memory (Best Stations Memory)	
• Reverse Demo		Using RDS Functions	37
• Feature Demo		What is RDS?	37
When using the DAB (Digital Audio Broadcasting) Tuner	18	Program Service Name Display	37
• About This Product's Indications		AF Function (Alternative Frequency)	38
• Operation		• Activating/Deactivating the AF Function	
Precaution	21	PI Seek Function	39
In Case of Trouble	21	• PI Seek	
Remote Controller and Care	22	• Auto PI Seek (for preset station)	
Using the Steering Remote Controller	22	Regional Function (Regional)	39
• Changing the DSP/MAIN UNIT Switch Setting		• Activating the Regional Function	
• Battery		Traffic Announcement Standby Function (Traffic Announcement)	40
Basic Operation	24	• Activating/Deactivating the TA Function	
To Listen to Music	24	• Canceling Traffic Announcements	
Basic Operation of Tuner	25	• Adjusting the TA Volume	
• Manual and Seek Tuning		• TP Alarm Function	
• Preset Tuning		PTY Function	42
• Band		• Searching the PTY	
		• News Program Interruption Setting (News)	
		• PTY Alarm	
		• Canceling Announcements	
		• PTY List	

Using the Built-in CD Player	45	Initial Setting	65
<ul style="list-style-type: none"> • Repeat Play (Play Mode) • Random Play (RandomPlay) • Scan Play (Scan Play) • Pause (Pause) • Selecting Tracks by Track Title List (Track List) • Disc Title Input (Title Input ABC) 		<ul style="list-style-type: none"> Entering the Initial Setting Menu Initial Setting Menu Functions <ul style="list-style-type: none"> • Changing the FM Tuning Step (FM tuning step) • Setting the DAB Priority Function (DAB Priority) • Switching the Auto PI Seek (Auto PI Seek) • Setting the Warning Tone (Warning Tone) • Switching the AUX Mode (AUX) • Setting the Subwoofer Control (Sub woofer control) • Setting the Dimmer (Dimmer) • Selecting the Illumination Color (Illumination Color) • Selecting the Wall Paper (Wall Paper) • Selecting the Brightness (Brightness) 	
Using Multi-CD Players	48	RFP Alert Function	71
<ul style="list-style-type: none"> • Repeat Play (Play Mode) • Random Play (Random Play) • Scan Play (Scan Play) • Pause (Pause) 		<ul style="list-style-type: none"> Activating the RFP Alert Feature Setting Entry Delay Time Activating Internal Speaker ON/OFF <ul style="list-style-type: none"> • Speaker Volume Output Adjustment Selecting Door Switching Systems <ul style="list-style-type: none"> • Door System Confirmation Operation of "RFP Alert" Arming Alert Disarming Alert Entry Detection 	
Compression and DBE (Compression)	50	Other Functions	76
<ul style="list-style-type: none"> • Comp./DBE ON/OFF Switching 		<ul style="list-style-type: none"> Switching the Entertainment Display Using the PGM Button (Program Function) <ul style="list-style-type: none"> • Setting the PGM Button • Using the PGM Button Using the AUX Source <ul style="list-style-type: none"> • Selecting the AUX Source • AUX Title Input Cellular Telephone Muting 	
ITS (Instant Track Selection)	51	CD Player and Care	79
<ul style="list-style-type: none"> • ITS Programming (ITS Memory) • ITS Play (ITS Play) • Erase a Track Program • Erase a Disc Program 		<ul style="list-style-type: none"> Precaution Built-in CD Player's Error Message 	
Disc Title	52	Specifications	81
<ul style="list-style-type: none"> • Disc Title Input (Title Input ABC) • Selecting Discs by Disc Title List (Disc List) • Selecting Tracks by Track Title List (Track List) 			
Audio Adjustment	55		
Selecting the Equalizer Curve	55		
Entering the Audio Menu	55		
Audio Menu Functions	56		
<ul style="list-style-type: none"> • Balance Adjustment (FAD/BAL) • Equalizer Curve Adjustment (Equalizer) • Equalizer Curve Fine Adjustment (Equalizer) • Loudness Adjustment (Loudness) • Subwoofer Output (Sub W-1) • Subwoofer Setting Adjustment (Sub W-2) • Non-Fading Output (Non Fade-1) • Non-Fading Output Level Adjustment (Non Fade-2) • High Pass Filter (High Pass) • Front Image Enhancer Function (FIE) • Source Level Adjustment (SLA) Function 			
Detaching and Replacing the Front Panel	64		
Theft Protection	64		
<ul style="list-style-type: none"> • Detaching the Front Panel • Replacing the Front Panel • Warning Tone 			

Installation

Note:

- Before finally installing the unit, connect the wiring temporarily, making sure it is all connected up properly, and the unit and the system work properly.
- Use only the parts included with the unit to ensure proper installation. The use of unauthorized parts can cause malfunctions.
- Consult with your nearest dealer if installation requires the drilling of holes or other modifications of the vehicle.
- Install the unit where it does not get in the driver's way and cannot injure the passenger if there is a sudden stop, like an emergency stop.
- The semiconductor laser will be damaged if it overheats, so don't install the unit anywhere hot — for instance, near a heater outlet.
- If installation angle exceeds 60° from horizontal, the unit might not give its optimum performance.

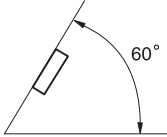

Installation with the Rubber Bush

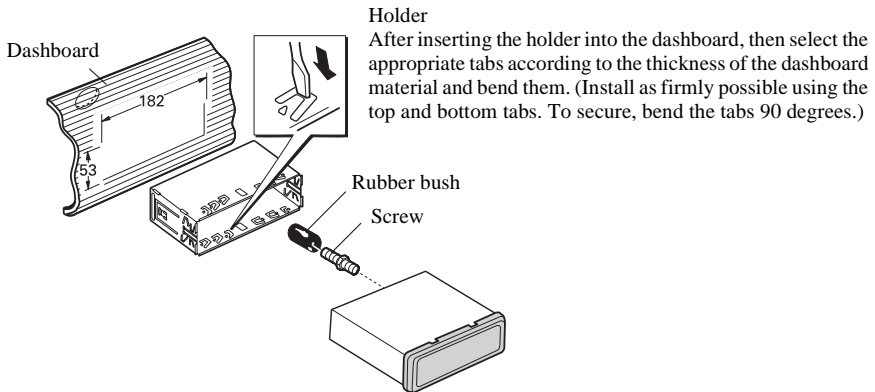

Removing the Unit

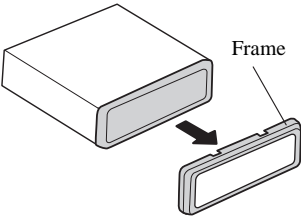

Pull out to remove the frame.
(When reattaching the frame, point the side with a groove downwards and attach it.)

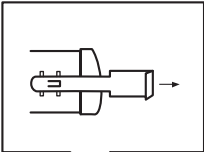

Insert the supplied extraction keys into the unit, as shown in the figure, until they click into place. Keeping the keys pressed against the sides of the unit, pull the unit out.

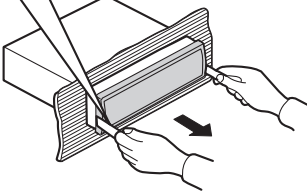

Installing the Steering Remote Control Unit

⚠ WARNING

- Avoid installing this unit in such a location where the operation of safety devices such as airbags is prevented by this unit. Otherwise, there is a danger of a fatal accident.
- Avoid installing this unit in such a location where the operation of the steering wheel and the gearshift lever may be prevented. Otherwise, it may result in a traffic accident.

⚠ CAUTION

- Installation of this unit requires specialized skills and experience. Installation of this unit should be entrusted to a dealer from whom you purchased this unit.
- Install this unit using only the parts supplied with this unit. If other parts are used, this unit may be damaged or could dismount itself, which leads to an accident or trouble.
- Install this unit as required by this manual. Failure to do so may cause an accident.
- Do not install this unit near the doors where rainwater is likely to be spilled on the unit. Incurion of water into the unit may cause smoke or fire.

⚠ WARNING

- Fix this unit securely to the steering wheel with the belt attached to the unit. If this unit is loose, it disturbs driving stability, which may result in a traffic accident.
- Do not attach this unit to the outer circumference of the steering wheel. Otherwise, it disturbs driving stability, causing a traffic accident. Always attach this unit to the inner circumference of the steering wheel as shown.

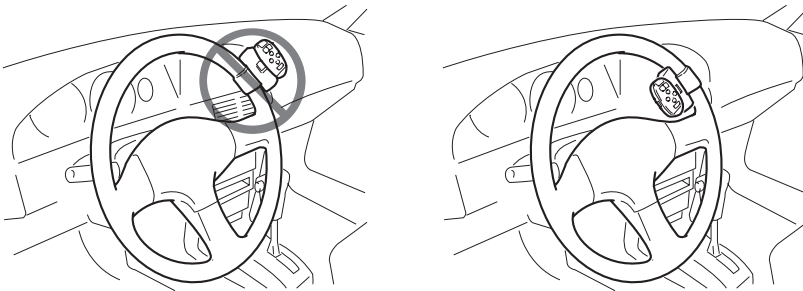

Note:

- Do not install this unit in such a place as may obstruct the driver's view.
- Since interior layout differs depending on the type of vehicle, the ideal installation location for the unit also differs. When installing the unit, select a location that assures optimum transmission of signals from the unit to the car stereo.

Installing the Unit on a Left-Hand-Drive Car

Note:

- When the unit is installed on a right-hand-drive car, the horizontal positions are inverted.

1. Secure inner holder to the inner circumference of the steering wheel with belt.

- Fit the inner holder to the steering wheel so that the arrow-marked side faces the driver as shown below.

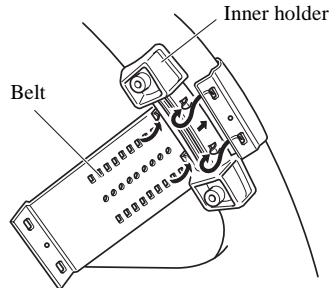

2. Cut the extra portion of the belt at the center of the inner holder.

- Keep the cut-off portion of the belt as a spare.

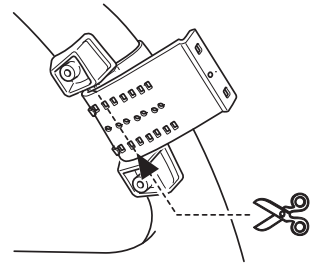

3. Install outer holder on the inner holder and secure with screws.

- Tighten the screws with the supplied hexagonal wrench.

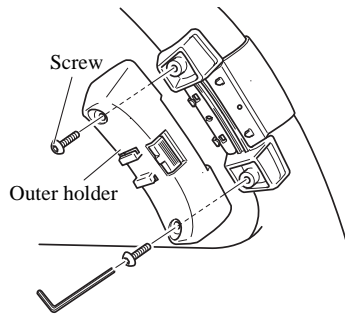

4. Install the remote control unit in the holder.

- When removing the remote control unit from the holder, move the corrugated release section toward the steering wheel and slide the remote control unit toward you.

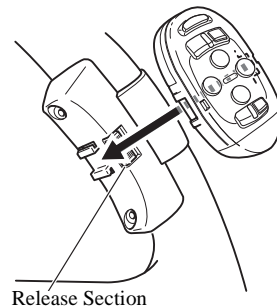

Connecting the Units

Note:

- This unit is for vehicles with a 12-volt battery and negative grounding. Before installing it in a recreational vehicle, truck, or bus, check the battery voltage.
- To avoid shorts in the electrical system, be sure to disconnect the ⊖ battery cable before beginning installation.
- Refer to the owner's manual for details on connecting the power amp and other units, then make connections correctly.
- Secure the wiring with cable clamps or adhesive tape. To protect the wiring, wrap adhesive tape around them where they lie against metal parts.
- Route and secure all wiring so it cannot touch any moving parts, such as the gear shift, handbrake, and seat rails. Do not route wiring in places that get hot, such as near the heater outlet. If the insulation of the wiring melts or gets torn, there is a danger of the wiring short-circuiting to the vehicle body.
- Don't pass the yellow lead through a hole into the engine compartment to connect to the battery. This will damage the lead insulation and cause a very dangerous short.
- Do not shorten any leads. If you do, the protection circuit may fail to work when it should.
- Never feed power to other equipment by cutting the insulation of the power supply lead of the unit and tapping into the lead. The current capacity of the lead will be exceeded, causing overheating.
- When replacing fuse, be sure to use only fuse of the rating prescribed on the fuse holder.
- Since a unique BPTL circuit is employed, never wire so the speaker leads are directly grounded or the left and right ⊖ speaker leads are common.
- The black lead is ground. Please ground this lead separately from the ground of high-current products such as power amps.
If you ground the products together and the ground becomes detached, there is a risk of damage to the products or fire.
- If the RCA pin jack on the unit will not be used, do not remove the caps attached to the end of the connector.
- Speakers connected to this unit must be high-power types with minimum rating of 45 W and impedance of 4 to 8 ohms. Connecting speakers with output and/or impedance values other than those noted here may result in the speakers catching fire, emitting smoke, or becoming damaged.

- When this product's source is switched ON, a control signal is output through the blue/white lead. Connect to an external power amp's system remote control or the car's Auto-antenna relay control terminal (max. 300 mA 12 V DC). If the car features a glass antenna, connect to the antenna booster power supply terminal.
- When an external power amp is being used with this system, be sure not to connect the blue/white lead to the amp's power terminal. Likewise, do not connect the blue/white lead to the power terminal of the auto-antenna. Such connection could cause excessive current drain and malfunction.
- To avoid short-circuiting, cover the disconnected lead with insulating tape. Especially, insulate the unused speaker leads without fail. There is a possibility of short-circuiting if the leads are not insulated.
- To prevent incorrect connection, the input side of the IP-BUS connector is blue, and the output side is black. Connect the connectors of the same colors correctly.
- If this unit is installed in a vehicle that does not have an ACC (accessory) position on the ignition switch, the red lead of the unit should be connected to a terminal coupled with ignition switch ON/OFF operations. If this is not done, the vehicle battery may be drained when you are away from the vehicle for several hours.



ACC position

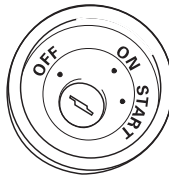

No ACC position

- Cords for this product and those for other products may be different colors even if they have the same function. When connecting this product to another product, refer to the supplied Installation manuals of both products and connect cords that have the same function.

Connection Diagram

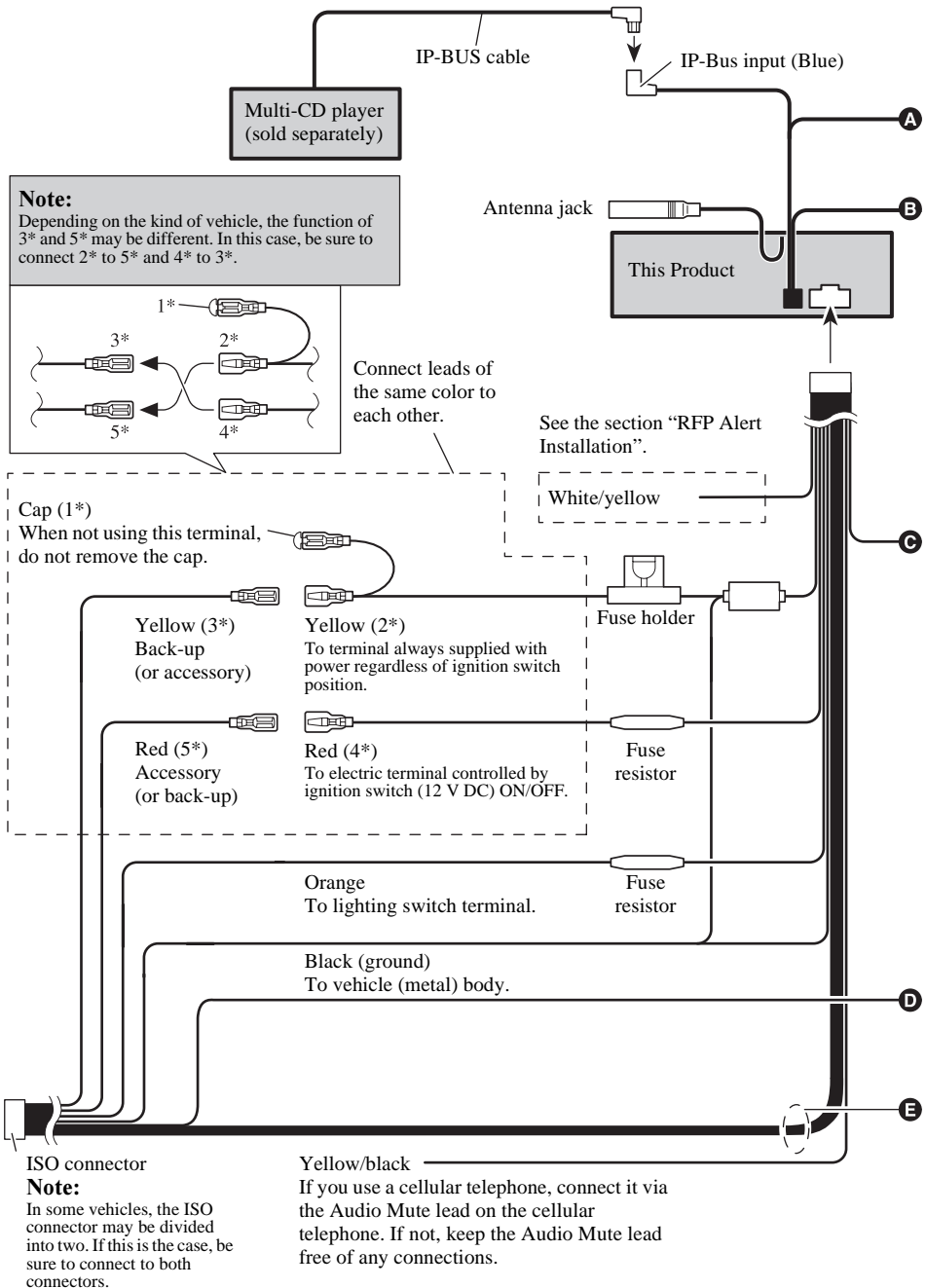

This product conforms to new cord colors.

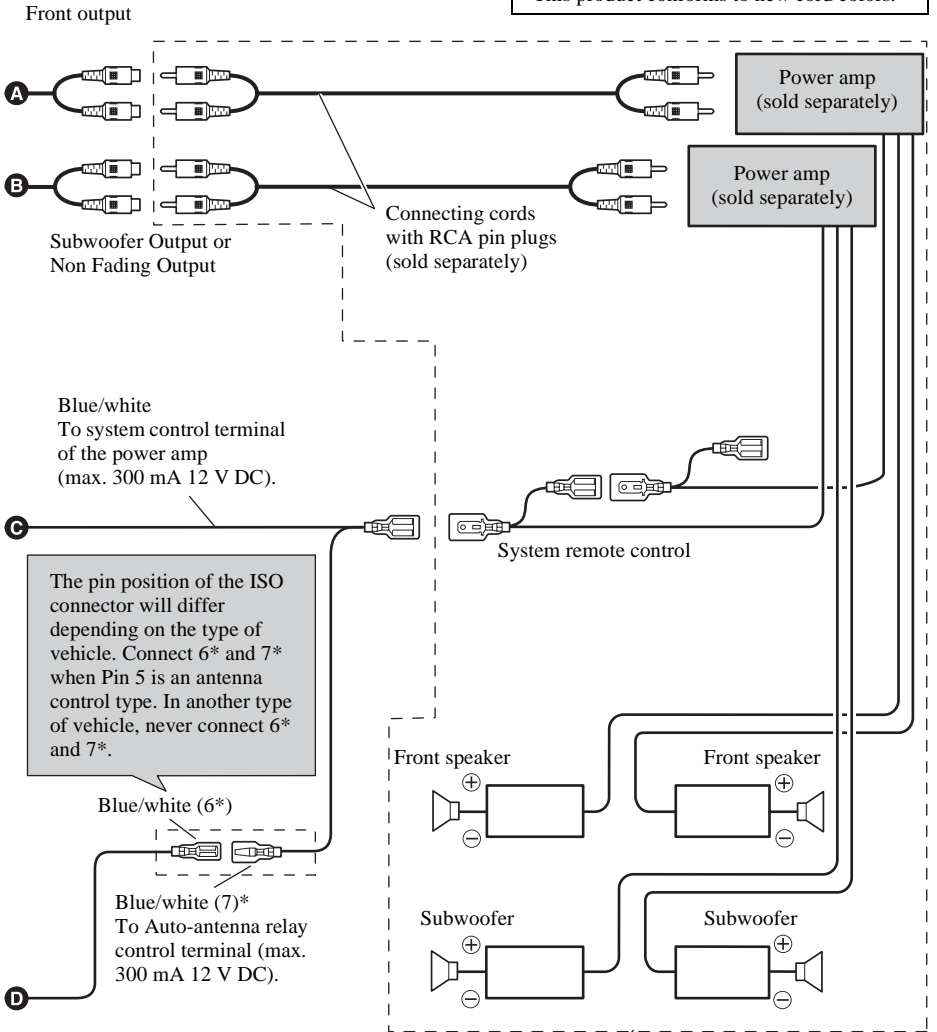

- E** — Speaker leads
- White :Front left ⊕
 - White/black :Front left ⊖
 - Gray :Front right ⊕
 - Gray/black :Front right ⊖
 - Green :Rear left ⊕ or Not Used
 - Green/black :Rear left ⊖ or Not Used
 - Violet :Rear right ⊕ or Subwoofer ⊕
 - Violet/black :Rear right ⊖ or Subwoofer ⊖

Perform these connections when using a different amp (sold separately).

Note:

When a subwoofer is connected to this unit instead of a rear right speaker, do not connect the rear left speaker lead to anything. For details, refer to the Initial Setting in this Manual.

CAUTION

- Because of the complexity of today's technically advanced vehicle wiring systems, we recommend that your RFP Alert be installed **ONLY** by a professional Pioneer installer.

Affix the included deterrent stickers to the inside of the front door windows.

Description

■ White/yellow (DOOR SWITCH)

This lead is used to trigger RFP Alert when any door is opened and may be connected to either positive or negative (+/-) type door pin switches.

Door Switches

The RFP Alert's door trigger input is designed to work with either positive or negative door pin switches. After hookup, simply set door system type from RFP Alert Setting Menu.

Domelight Delay-RFP Alert will wait for last door to close and courtesy light to turn off before Exit Delay Timer Starts.

DOOR SWITCH (White/yellow)

■ Grounding Type Switch:

Most European, Japanese, GM and Chrysler vehicles.

Note:

- Set RFP Alert to recognize ground trigger from RFP Alert Setting Menu. Set Door System to “Door System: Negative, Current mode: Close”.

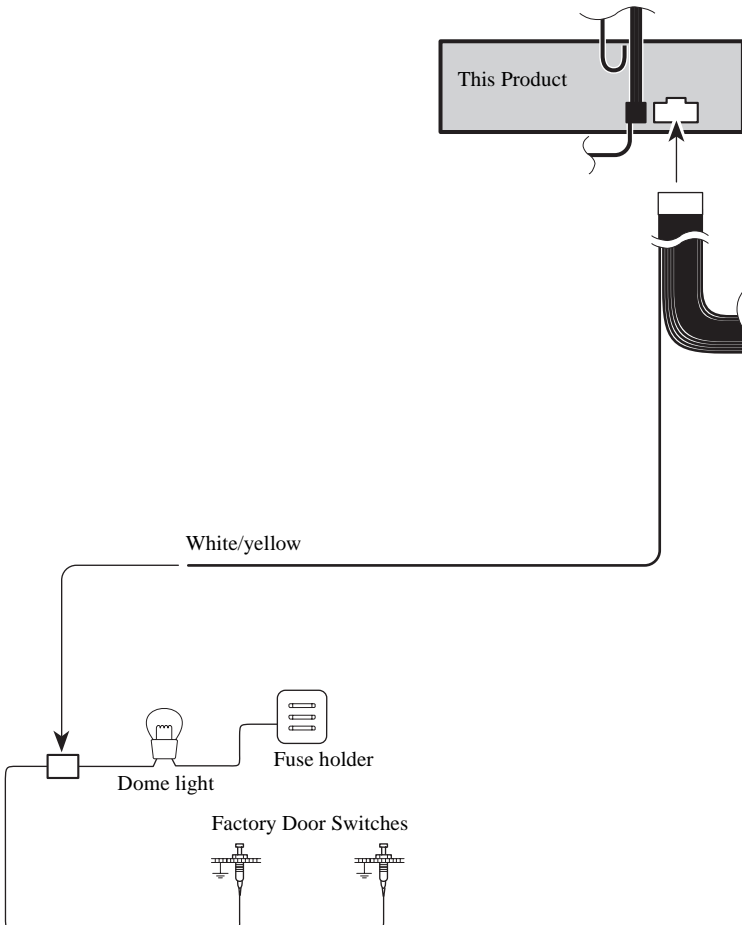

RFP Alert Installation

■ Positive (Non-grounding) Type Switch:

Jaguar, Mercedes, Ford

Note:

- Set RFP Alert to recognize positive trigger from RFP Alert Setting Menu. Set Door System to “Door System: Positive, Current mode: Close”.

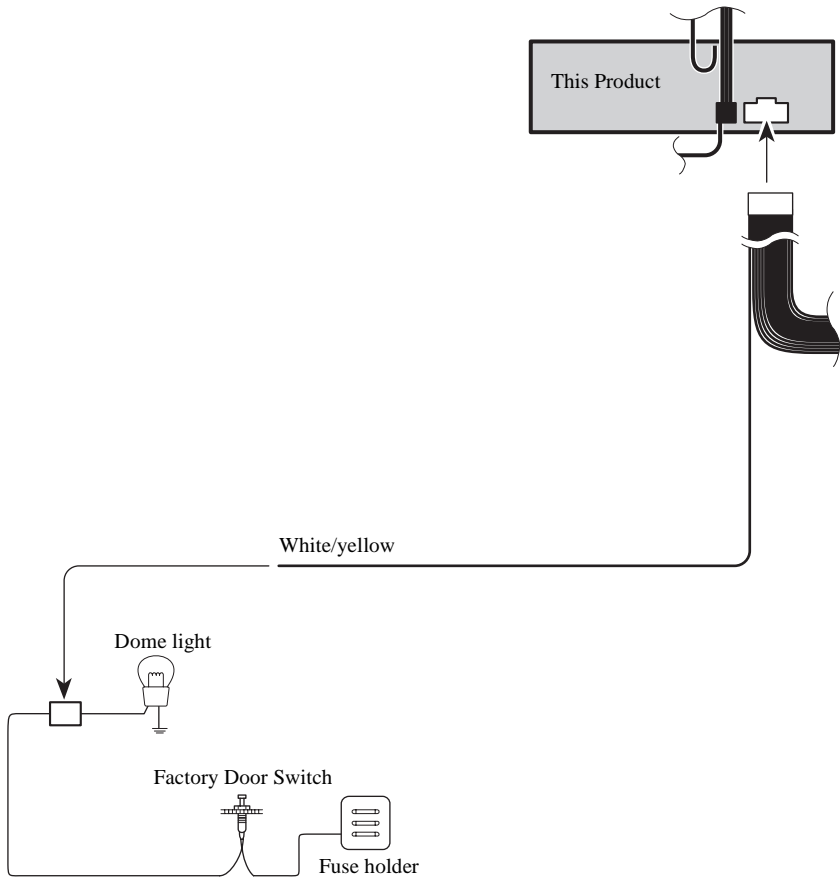

■ Installing New Pin Switches

Separately sold pin switches are available that can be used to protect your vehicle’s trunk, hood, etc. When you purchase these, make sure that you first confirm that they can be used with your vehicle’s door system type.

Follow the makers instructions as to installation and wiring.

■ Head Unit

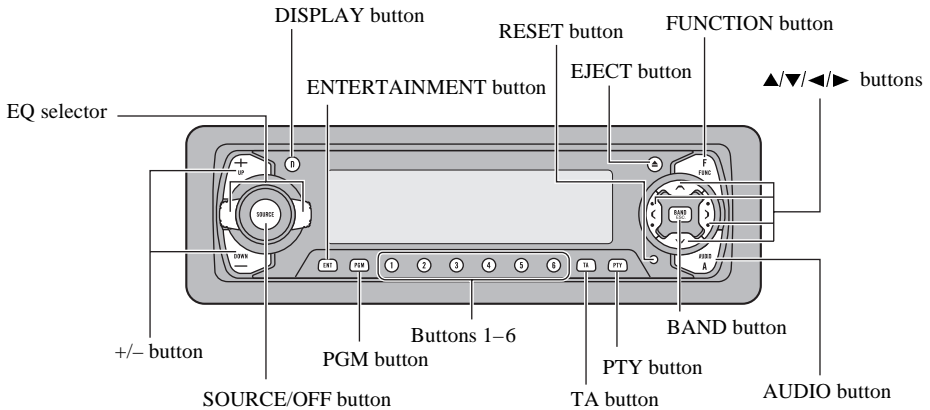

■ Steering Remote Controller

A steering remote controller that enables remote operation of the head unit is supplied. Operation is the same as when using buttons on the head unit.

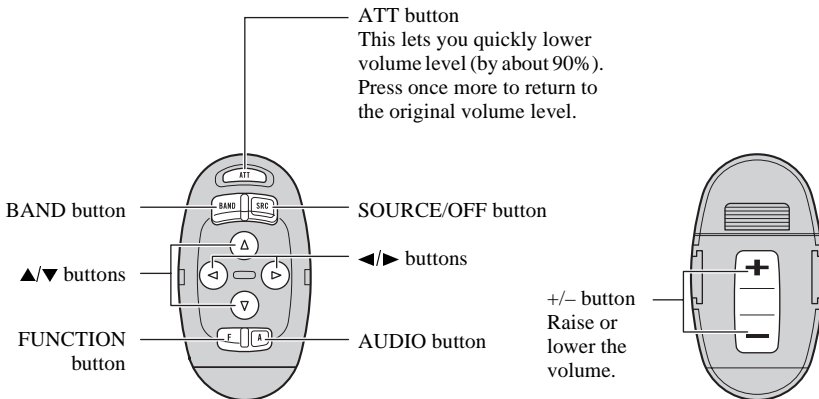

About This Product

- This product complies with the EMC Directives (89/336/EEC, 92/31/EEC) and CE Marking Directive (93/68/EEC).

The tuner frequencies on this product are allocated for use in Western Europe, Asia, the Middle East, Africa and Oceania. Use in other areas may result in improper reception. The RDS function operates only in areas with FM stations broadcasting RDS signals.

About This Manual

This product features a number of sophisticated functions ensuring superior reception and operation. All are designed for the easiest possible use, but many are not self-explanatory. This manual is intended to help you benefit fully from their potential and to maximize your listening enjoyment.

We recommend that you familiarize yourself with the functions and their operation by reading through the manual before you begin using this product. It is especially important that you read and observe the “Precaution” on page 21 and in other sections.

This manual explains head unit operation. You can perform the same operations with the steering remote controller. The steering remote controller offers the convenience of ATT, a function not provided on the head unit.

Resetting the Microprocessor

The microprocessor must be reset under the following conditions:

- When using this product for the first time after installation.
- When the machine fails to operate properly.
- When strange (incorrect) messages appear on the display.

- **To reset the microprocessor, press the RESET button on the head unit with a pen tip or other pointed instrument.**

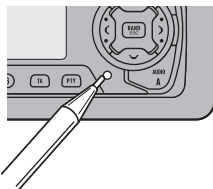

About the Demo Mode

This product features two demonstration modes. One is the Reverse Demo mode, the other is the Feature Demo mode.

■ Reverse Demo

If you do not perform an operation within about 30 seconds, screen indications start to reverse, and then continue reversing every 10 seconds. Pressing button 5 when power to this product is switched OFF while the ignition switch is set to ACC or ON cancels the Reverse Demo mode. Pressing button 5 again to start the Reverse Mode.

■ Feature Demo

The Feature Demo automatically starts when power to this product is switched OFF while the ignition switch is set to ACC or ON. Pressing button 6 during Feature Demo operation cancels the Feature Demo mode. Pressing button 6 again to start the Feature Mode. Remember that if the Feature Demo continues operating when the car engine is switched OFF, it may drain battery power.

Note:

- You cannot cancel a Demo mode when the front panel is open.
- The red lead (ACC) of this product should be connected to a terminal coupled with ignition switch ON/OFF operations. If this is not done, the vehicle battery may be drained.

When using the DAB (Digital Audio Broadcasting) Tuner

You can use this product with a separately sold hide-away DAB tuner (GEX-P900DAB, GEX-P900DABII). For details concerning operation, refer to the DAB Tuner's Operation Manuals. This section provides information on DAB operations with this product which differs from that described in the DAB Tuner's Operation Manual.

■ About This Product's Indications

The following is an explanation of this unit's indications.

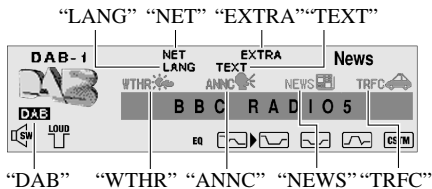

■ Indications that light when Function is switched ON

Indicator	Function
NET	Service Follow (Service Follow)
LANG	Language Filter (Language Filter)
WTHR*	Area Weather Flash (Weather)
ANNC*	Announce (Announce)
NEWS*	News Flash (News)
TRFC*	Road Traffic Flash or Transport Flash

* If the set Announcement Support is received, the icon on the right lights.

■ DAB Status Indications

Indicator	Status
EXTRA	The currently received Service has a Secondary Service Component.
TEXT	The currently received Service has a Dynamic Label.
DAB	When DAB reception is possible.

■ Operation

With this product, operation of the following four functions differs. (Reference pages are in the Hide-away DAB Tuner's Operation Manual.)

- Changing the Label (Refer to page 12.)
- Changing Display Indications (Refer to page 13.)
- Operating Announcements with Function Menu (Refer to page 19.)
- Service List Function (Newly equipped for this product)

■ Changing the Label

Each press of the DISPLAY button changes the display in the following order:

Service Component Label (Service) → Dynamic Label (Text) → Ensemble Label (Ensemble)
→ Service Label

Note:

- With a Service Component that has no Service Component Label or Dynamic Label, switching to Service Component Label and Dynamic Label is not possible. With displays other than Service Label, if you do not perform an operation within 8 seconds or press a button other than the DISPLAY button, the display returns to Service Label Indicators.

■ Changing Display Indications

This product doesn't have this function.

■ Operating Announcements with the Function Menu

When operating with the ◀/▶ button at step 2, indications are displayed in the following order:

News Flash (News) ↔ Area Weather Flash (Weather) ↔ Announce (Announce)

Note:

- The Announce mode (Announce) unifies three modes such as Warning/Service, Event Flash and Special Event.

Before Using This Product

■ Service List Function

This product is also equipped with the Service List Function in the Function Menu. It is possible to select the desired Service among the memorized Services in the Service List. Function Menu Functions appear on the display in the following order:

Service List (SRVC. List) → Language Filter (Language Filter) → Announcement Support (Announcement Support) → Service Follow (Service Follow) → Service Component (Primary/Secondary) → Dynamic Label (DAB Text)

1. Press the FUNCTION button and select the Service List mode (SRVC. List) in the Function Menu.

2. Select the desired Service with the ◀/▶ buttons.

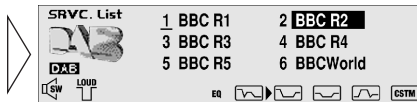

Note:

- You can also select and recall the desired Service directly with the 1 to 6 buttons.

3. Recall the selected Service with the ▲ button.

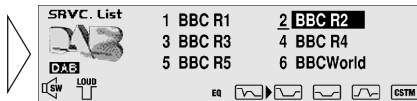

Precaution

- A “CLASS 1 LASER PRODUCT” label is affixed to the bottom of the player.



- The Pioneer CarStereo-Pass is for use only in Germany.
- Keep this manual handy as a reference for operating procedures and precautions.
- Always keep the volume low enough for outside sounds to be audible.
- Protect the product from moisture.
- If the battery is disconnected, the preset memory will be erased and must be reprogrammed.

In Case of Trouble

Should this product fail to operate properly, contact your dealer or nearest authorized Pioneer Service Station.

Using the Steering Remote Controller

Precaution:

- Do not operate this unit while manipulating the steering wheel as it might result in a traffic accident.
- If you have to operate this unit unavoidably when driving, look ahead carefully to avoid the risk of being involved in a traffic accident.
- If any of the following troubles occur, immediately stop using this unit and consult with the dealer from whom you purchased it:
 - the unit is smoking.
 - the unit is emitting abnormal odor.
 - a foreign object has entered the unit.
 - liquid has been spilled on or into the unit.If you continue to use this unit without finding a remedy, the unit may be damaged badly, resulting in a serious accident or fire.
- Do not leave this unit free (unattached) inside the car. When the car stops or turns a curve, the unit might drop on the floor. If the unit rolls under the brake pedal, it might prevent the driver from braking well, causing serious trouble. Be sure to fix this unit to the steering wheel.
- Do not disassemble or modify this unit. To do so may cause a fault.

■ Changing the DSP/MAIN UNIT Switch Setting

When this product is connected to a DSP, the switch under the back lid must be changed to the DSP position, use a tapered bar such as a ball-point pen. If you do not connect a DSP to this product, do not change to the DSP position.

Precaution:

- If you do not set the switch under the back lid as the above, correct operations will not be possible by the remote controller.

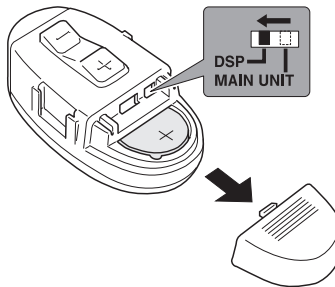

■ Battery

■ Install the Lithium Battery

- Remove the cover on the back of the steering remote controller and insert the battery with the (+) and (-) poles pointing in the proper direction.

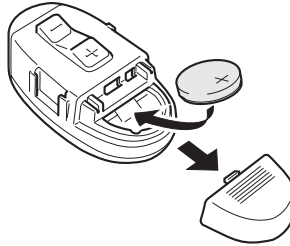

■ Replacing the Lithium Battery

- Remove the lithium battery.

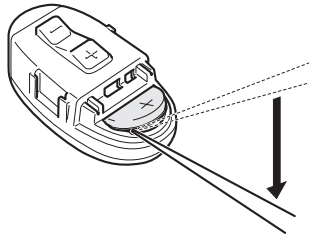

Precaution:

- Replace the battery with a CR2032 lithium battery.
- Replace the battery in the unit using a non metallic tapered instrument.

⚠ WARNING:

- Keep the lithium battery out of reach of children. Should the battery be swallowed, immediately consult a doctor.

⚠ CAUTION:

- Do not recharge, disassemble, heat or dispose of battery in a fire.
- Use a CR2032 (3 V) lithium battery only. Never use other types of battery with this unit.
- Do not handle the battery with metallic tools.
- Do not store the lithium battery with metallic materials.
- Dispose of the used lithium battery, in compliance with applicable laws and regulations.
- Always check carefully that you are loading the battery with its (+) and (-) poles facing in the proper directions.

To Listen to Music

The following explains the initial operations required before you can listen to music.

Note:

- Loading a disc in this product. (Refer to page 26.)

1. Select the desired source. (e.g. Tuner)

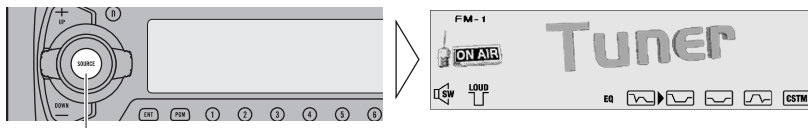

Each press changes the Source ...

Each press of the SOURCE/OFF button selects the desired source in the following order:

Built-in CD player (Compact Disc) → Tuner → DAB (Digital Audio Broadcasting) Tuner → Multi-MD player → Multi-CD player → External Unit → AUX

Note:

- External Unit refers to a Pioneer product (such as one available in the future) that, although incompatible as a source, enables control of basic functions by this product. Only one External Unit can be controlled by this product.
- In the following cases, the sound source will not change:
 - * When a product corresponding to each source is not connected to this product.
 - * No disc is set in this product.
 - * No magazine is set in the Multi-CD player.
 - * No disc is set in the Multi-MD player.
 - * AUX (external input) is set to OFF. (Refer to page 67.)
- When this product's blue/white lead is connected to the car's Auto-antenna relay control terminal, the car's Auto-antenna extends when this product's source is switched ON. To retract the antenna, switch the source OFF.

2. Raise or lower the volume.

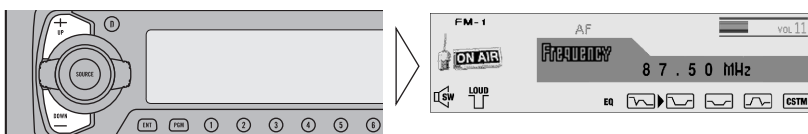

3. Turn the source OFF.

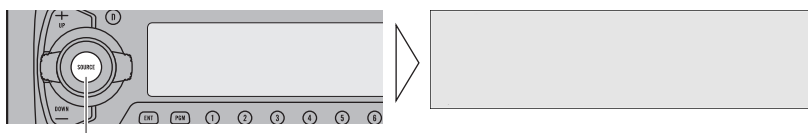

Hold for 1 second

Basic Operation of Tuner

This product's AF function can be switched ON and OFF. AF should be switched OFF for normal tuning operations. (Refer to page 38.)

Manual and Seek Tuning

- You can select the tuning method by changing the length of time you press the ◀▶ button.

Manual Tuning (step by step)	0.5 seconds or less
Seek Tuning	0.5 seconds or more

Note:

- If you continue pressing the button for longer than 0.5 seconds, you can skip broadcast stations. Seek Tuning starts as soon as you release the button.
- Stereo indicator “Ⓞ” lights when a stereo station is selected.

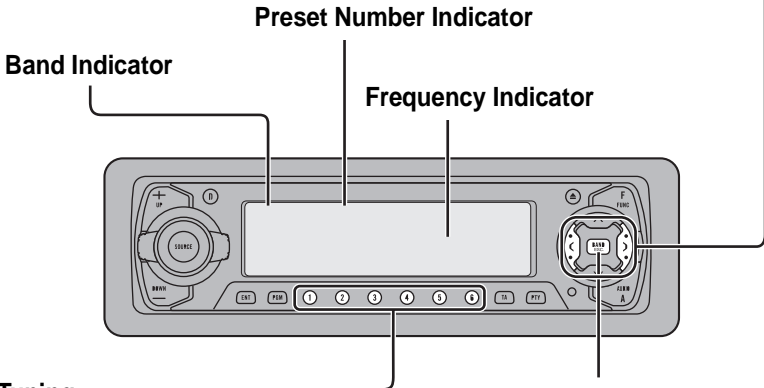

Preset Tuning

- You can memorize broadcast stations in buttons 1 through 6 for easy, one-touch station recall.

Preset station recall	2 seconds or less
Broadcast station preset memory	2 seconds or more

Note:

- Up to 18 FM stations (6 in FM-1, FM-2 and FM-3) and 6 MW/LW stations can be stored in memory.
- You can also use the ▼ or ▲ buttons to recall broadcast stations memorized in buttons 1 through 6.

Band

FM-1 → FM-2 → FM-3 → MW/LW

Basic Operation of Built-in CD Player

Switching the Display

Each press of the DISPLAY button changes the display in the following order:
Playback mode (Play Time) → Disc Title

Note:

- If you switch displays when disc titles have not been input, “No Title” is displayed.

Eject

Press the EJECT button, and you can open the front panel before ejection.

In case of opening the front panel, you can just eject a CD.

Note:

- The CD function can be turned ON/OFF with the disc remaining in this product. (Refer to page 24.)
- A disc left partially inserted after ejection may incur damage or fall out.

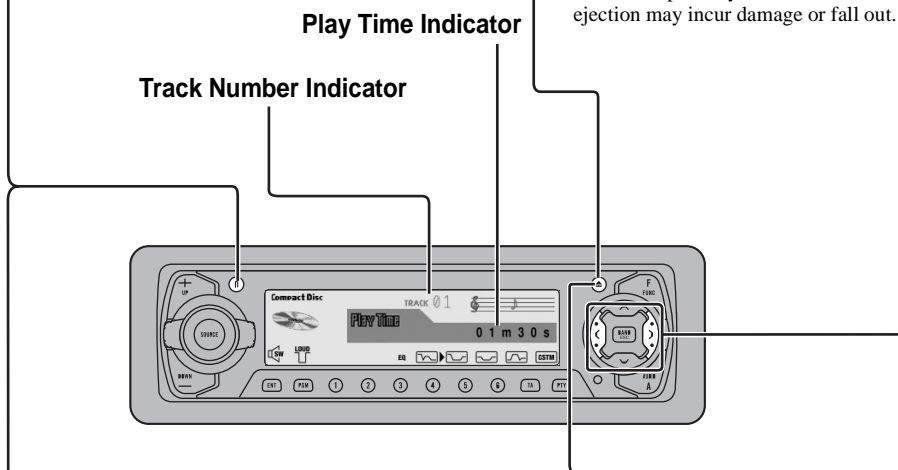

Switching the Display (only for CD TEXT Discs)

Each press of the DISPLAY button changes the display in the following order:
Play mode (Play Time) → Disc Title → Disc Artist → Track Title → Track Artist

With text longer than 20 letters, you can scroll to see the rest of the text by pressing the DISPLAY button for 2 seconds.

Note:

- A CD TEXT disc is a CD featuring recorded text information such as Disc Title, Artist Name and Track Title.
- If certain text information is not recorded on a CD TEXT disc, “No ~” (e.g. “No Title”) is displayed.

Track Search and Fast Forward/Reverse

- You can select between Track Search or Fast Forward/Reverse by pressing the ◀/▶ button for a different length of time.

Track Search	0.5 seconds or less
Fast forward/Reverse	Continue pressing

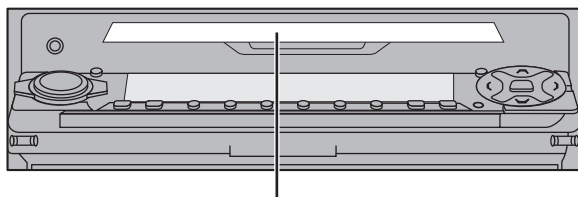

Disc Loading Slot

If a CD is inserted, the front panel is closed automatically. The Built-in CD player plays one standard 12 cm or 8 cm (single) CD at a time. Do not use an adapter when playing 8 cm CD.

Note:

- If a disc cannot be inserted fully or playback fails, make sure the recorded side is down. Push the EJECT button and check the disc for damage before reinserting it.
- If the Built-in CD player cannot operate properly, an error message (such as “ERROR-14”) appears on the display. Refer to “Built-in CD Player’s Error Message” on page 80.

Open

Press the EJECT button for 1 second, and you can open the front panel without ejecting a CD. In case of opening the front panel, you can close it.

Note:

- When opening the front panel, the 1 to 6 buttons are not available.

WARNING:

- Do not use with the front panel left open. If you do leave it open, it may result in injury in the event of an accident.

Basic Operation of Multi-CD Player

This product can control a Multi-CD player (sold separately).

Switching the Display

Each press of the DISPLAY button changes the display in the following order:

Playback mode (Play Time)

→ Disc Title

Note:

- If you switch displays when disc titles have not been input, "No Title" is displayed.

Track Search and Fast Forward/Reverse

- You can select between Track Search or Fast forward/Reverse by pressing the ◀/▶ button for a different length of time.

Track Search	0.5 seconds or less
Fast forward/Reverse	Continue pressing

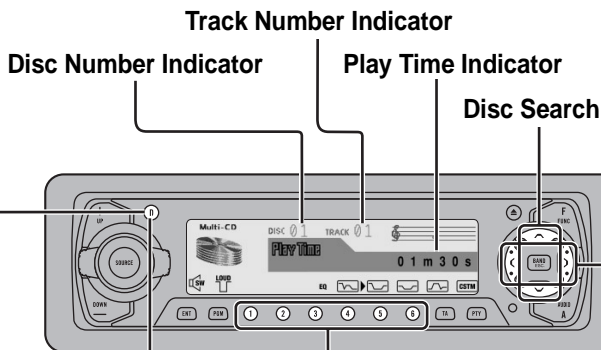

Switching the Display

(When playing a CD TEXT disc on a CD TEXT compatible Multi-CD Player)

Each press of the DISPLAY button changes the display in the following order:

Playback mode (Play Time) → Disc Title → Disc Artist → Track Title → Track Artist

With text longer than 20 letters, you can scroll to see the rest of the text by pressing the DISPLAY button for 2 seconds.

Note:

- A CD TEXT disc is a CD featuring recorded text information such as Disc Title, Artist Name and Track Title.
- If certain text information is not recorded on a CD TEXT disc, "No ~" (e.g. "No Title") is displayed.
- You cannot switch to the Disc Title Input mode in the Detailed Setting Menu.

Disc Number Search (for 6-Disc, 12-Disc types)

- You can select discs directly with the 1 to 6 buttons. Just press the number corresponding to the disc you want to listen to.

Note:

- When a 12-Disc Multi-CD Player is connected and you want to select disc 7 to 12, press the 1 to 6 buttons for 2 seconds.

Disc Number Rough Search (for 50-Disc type only)

This handy function lets you select discs loaded in a 50-Disc Multi-CD Player using the 1 to 5 buttons. The 50 discs are divided into five blocks, with each of the 1 to 5 buttons assigned to a block.

- Select the desired block with the 1 to 5 buttons.

Note:

- After completing a rough search, use the ▲ and ▼ buttons to select a desired disc.

Note:

- The Multi-CD player may perform a preparatory operation, such as verifying the presence of a disc or reading disc information, when the power is turned ON or a new disc is selected for playback. "READY" is displayed.
- When a magazine is loaded into a 50-Disc type Multi-CD Player, information on all the discs in the magazine is read.

If you start playing a disc on a 50-Disc type Multi-CD Player before reading of information on all discs has been completed, reading of information stops part way through. This will prevent you from using the ITS function. (If you try and use this function, "Not Ready" is displayed.)

If this happens, reading of information begins again when you switch to a component other than the 50-Disc Type Multi-CD Player.

- If the Multi-CD player cannot operate properly, an error message such as "ERROR-14" is displayed. Refer to the Multi-CD Player Owner's Manual.
- If there are no discs in the Multi-CD player magazine, "No Disc" is displayed.
- "LOADING" will be displayed in the following cases:
 - * If the disc in the extra tray is selected.
 - * If the disc is moved from the extra tray to the magazine.
(Refer to the 50-Disc Type Multi-CD Player Owner's Manual.)
- You cannot use the "Ejecting a Single Disc", "Frequency Play", "Music Group Play" or "ABC Disc Title Search" functions with this product.

Corresponding Display Indications and Buttons

This product's display features Key Guidance Indicators. These light to indicate which of the ▲/▼/◀/▶ buttons you can use. When you're in the Function Menu (refer to next section), Detailed Setting Menu (refer to page 34), Initial Setting Menu (refer to page 65) or Audio Menu (refer to page 55), they also make it easy to see which ▲/▼/◀/▶ buttons you can use to switch functions ON/OFF, switch repeat selections and perform other operations.

Indicator and corresponding buttons are shown below.

■ Head Unit

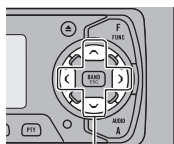

①

■ Steering Remote Controller



■ Display



①

When ① is lit in the display, perform appropriate operations with the ① buttons.

Entering the Function Menu

The Function Menu lets you operate simple functions for each source.

Note:

- After entering the Function Menu, if you do not perform an operation within about 30 seconds, the Function Menu is automatically canceled.

1. Select the desired mode in the Function Menu. (Refer to next section, “Function Menu Functions”.)

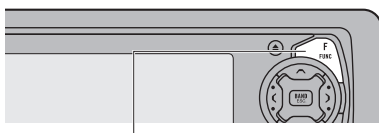

Each press changes the Mode ...

2. Operate a mode. (e.g. Random Play)



The button used and the operation it performs are indicated by the key guidance indicator. Press the ▲ button to switch the key guidance indicator ON, and the ▼ button to switch it OFF.

3. Cancel the Function Menu.

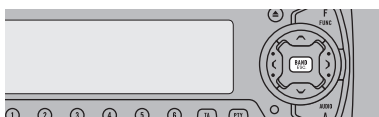

Function Menu Functions

The following chart shows functions for each source in the Function Menu. The chart also shows indications for each function, operations and buttons used to perform operations. For more details, or when you want to know about an operation, refer to the page number indicated in the chart.

■ Tuner

Function name (Display)	Button: Operation	Page
Best Stations Memory (Best Stations Memory)	▲: ON ▼: OFF	36
Regional Function (Regional)	▲: ON ▼: OFF	39
Local Seek Tuning (LOCAL)	1 ▲: ON ▼: OFF 2 ◀ or ▶: Select (Sensitivity)	36
TA Function (Traffic Announcement)	▲: ON ▼: OFF	40
News Program Interruption Setting (News)	▲: ON ▼: OFF	43
AF Function (AlternativeFrequency)	▲: ON ▼: OFF	38

■ Built-in CD Player

Function name (Display)	Button: Operation	Page
Selecting Tracks by Track Title List (Track List)	1 ◀ or ▶: Select (Track Title) 2 ▲: Play	47
Repeat Play (Play Mode)	▲: ON ▼: OFF	45
Random Play (RandomPlay)	▲: ON ▼: OFF	45
Scan Play (Scan Play)	▲: ON ▼: OFF	46
Pause (Pause)	▲: ON ▼: OFF	46

■ Multi-CD Player

Function name (Display)	Button: Operation	Page
Repeat Play (Play Mode)	◀ or ▶: Select (Play Range)	48
Selecting Discs by Disc Title List (Disc List)	1 ◀ or ▶: Select (Disc Title) 2 ▲: Play	54
Selecting Tracks by Track Title List (Track List)	1 ◀ or ▶: Select (Track Title) 2 ▲: Play	54
Random Play (RandomPlay)	▲: ON ▼: OFF	48
Scan Play (Scan Play)	▲: ON ▼: OFF	49
ITS Play (ITS Play)	▲: ON ▼: OFF	51
Pause (Pause)	▲: ON ▼: OFF	49
Compression and DBE (Compression)	▲ or ▼: Select (Sound Quality Function)	50

Entering the Detailed Setting Menu

In the Detailed Setting Menu, you can operate convenient, complex functions for each source.

1. Enter the Detailed Setting Menu.

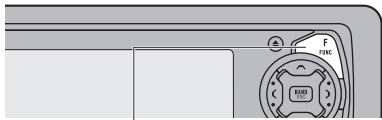

Hold for 2 seconds

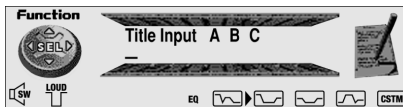

2. Select the desired mode.

(Refer to next section, “Detailed Setting Menu Functions”.)



Each press changes the Mode ...

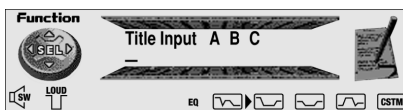

3. Operate a mode.

4. Cancel the Detailed Setting Menu.



Note:

- You can cancel the Detailed Setting Menu by pressing the FUNCTION button again for 2 seconds.

Detailed Setting Menu Functions

The following chart shows functions for each source in the Detailed Setting Menu. The chart also shows indications for each function, operations and buttons used to perform operations. For more details, or when you want to know about an operation, refer to the page number indicated in the chart.

■ Tuner

Function name (Display)	Button: Operation	Page
Program Function (Program Function)	1 ◀ or ▶: Select (Function) 2 ▲: Memory	76

■ Built-in CD Player

Function name (Display)	Button: Operation	Page
Disc Title Input (Title Input ABC)	1 ▲ or ▼: Select (Character) 2 ◀ or ▶: Select (Position) 3 ▶: Memory	47
Program Function (Program Function)	1 ◀ or ▶: Select (Function) 2 ▲: Memory	76

■ Multi-CD Player

Function name (Display)	Button: Operation	Page
Disc Title Input (Title Input ABC)	1 ▲ or ▼: Select (Character) 2 ◀ or ▶: Select (Position) 3 ▶: Memory	52
ITS Programming (ITS Memory)	▲: Memory	51
Program Function (Program Function)	1 ◀ or ▶: Select (Function) 2 ▲: Memory	76

Tuner Operation

■ Local Seek Tuning (LOCAL)

When Local mode is ON (“LOC” indicator lights), you can only select broadcast stations providing strong reception.

1. Press the **FUNCTION** button and select the Local mode (LOCAL) in the Function Menu.

2. Switch the Local ON/OFF with the **▲/▼** buttons.



3. Select the desired Local Seek sensitivity with the **◀/▶** buttons.



FM : LEVEL 1 ↔ LEVEL 2 ↔ LEVEL 3 ↔ LEVEL 4
MW/LW : LEVEL 1 ↔ LEVEL 2

Note:

- The LEVEL 4 setting allows reception of only the strongest stations, while lower settings let you receive progressively weaker stations.

■ Best Stations Memory (Best Stations Memory)

The BSM (Best Stations Memory) function stores stations in memory automatically.

1. Press the **FUNCTION** button and select the BSM mode (Best Stations Memory) in the Function Menu.

2. Switch the BSM ON with the **▲** button.

The stations with the strongest signals will be stored under buttons 1–6 and in order of their signal strength.



- To cancel the process, press the **▼** button in the Function Menu before memorization is complete.



What is RDS?

RDS (Radio Data System) is a system for transmitting data along with FM programs. This data, which is inaudible, provides a variety of features such as: program service name, program type display, traffic announcement standby, automatic tuning and program type tuning, intended to aid radio listeners in tuning to a desired station.

Note:

- RDS service may not be provided by all stations.
- RDS functions, like AF (Alternative Frequencies search) and TA (Traffic Announcement standby), are only active when your radio is tuned to RDS stations.

Program Service Name Display

With this function, the names of networks/stations providing RDS services replace the frequency on the display a few seconds after they are tuned in.

- **When you want to know the frequency of the current station, change the display.**

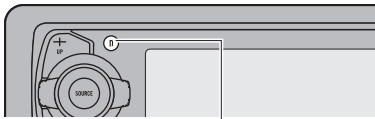

Each press changes the Display ...

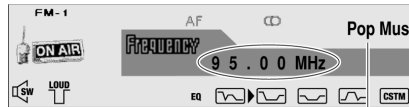

PTY Information

Each press of the DISPLAY button selects the display in the following order:
Frequency → Program Service Name

Note:

- After switching displays, if you do not perform an operation within 8 seconds, the Program Service Name is automatically displayed.

■ PTY Information

PTY (Program Type ID code) information for the currently tuned station appears on the display for 8 seconds. The information is correlated with the list in the section “PTY List” on page 44.

Note:

- If a PTY code of zero is received from a station, “None” will be displayed. This indicates that the station has not defined its program contents.

■ Frequency

The frequency of the current station appears on the display for 8 seconds.

AF Function (AlternativeFrequency)

The AF (Alternative Frequencies search) function is used to search for other frequencies in the same network as the currently tuned station. It automatically retunes the receiver to another frequency in the network which is broadcasting a stronger signal when there are problems with reception of the currently tuned station or better reception is possible on a different frequency.

Note:

- AF tunes the receiver only to RDS stations when you use Seek tuning or BSM Auto Memory with the “AF” indicator ON.
- When you recall a preset station, the tuner may update the preset station with a new frequency from the station’s AF list. (This is only available when using presets on the FM-1 and FM-2 bands.) No preset number appears on the display if the RDS data for the station received differs from that for the originally stored station.
- Sound may be temporarily interrupted by another program during an AF frequency search.
- When the tuner is tuned to a non-RDS station, the “AF” indicator flashes.
- AF can be switched ON or OFF independently for each FM band.

■ Activating/Deactivating the AF Function

AF is set to ON by default.

1. Press the **FUNCTION** button and select the **AF mode (AlternativeFrequency)** in the **Function Menu**.
2. Activate or deactivate **AF** while in an **FM band**.

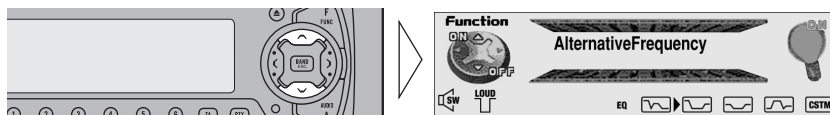

PI Seek Function

The tuner searches for another frequency broadcasting the same programming. “PI Seek” appears on the display and the radio volume is muted during a PI Seek. The muting is discontinued after completion of the PI Seek, whether or not the PI seek has succeeded. If the PI Seek is unsuccessful, the tuner returns to the previous frequency.

■ PI Seek

If the tuner fails to locate a suitable alternative frequency or if the broadcasting signal is too weak for proper reception, the PI Seek will automatically start.

■ Auto PI Seek (for preset station)

When preset stations cannot be recalled, as when traveling long distances, the product can be set to perform PI Seek also during preset recall.

The default setting for Auto PI Seek is OFF.

Note:

- Refer to “Initial Setting” for details on how to switch Auto PI Seek ON/OFF.

Regional Function (Regional)

When AF is used to retune the tuner automatically, the Regional function limits the selection to stations broadcasting regional programs.

Note:

- Regional programming and regional networks are organized differently depending on the country (i.e., they may change according to the hour, state or broadcast area).
- The preset number may disappear on the display if the tuner tunes in a regional station which differs from the originally set station.
- “REG” is displayed if you activate the Regional function when the Function Menu is canceled.

■ Activating the Regional Function

The Regional function can be turned ON independently for each FM band.

1. Press the **FUNCTION** button and select the **Regional mode (Regional)** in the **Function Menu**.
2. Activate or deactivate **Regional** while in an **FM band**.

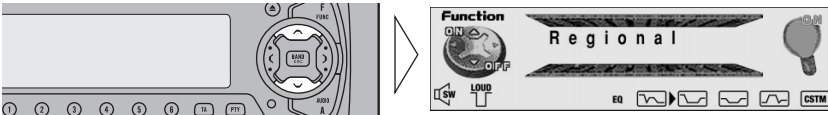

Traffic Announcement Standby Function (Traffic Announcement)

The TA (Traffic Announcement standby) function lets you receive traffic announcements automatically, no matter what source you are listening to. The TA function can be activated for either a TP station (a station that broadcasts traffic information) or an EON TP station (a station carrying information which cross-references TP stations).

■ Activating/Deactivating the TA Function

1. Tune in a TP or EON TP station.

The TP indicator (“”) lights when the tuner is tuned to a TP station or an EON TP station.

2. Activate the TA function.

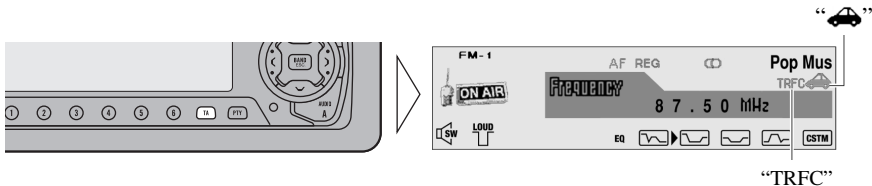

The “TRFC” indicator lights, indicating that the tuner is waiting for traffic announcements.

Repeat the preceding operation when no traffic announcement is being received to deactivate the TA function.

Note:

- You can also switch the TA function ON/OFF in the Function Menu.
- The system switches back to the original source following traffic announcement reception.
- The TA function can be activated from sources other than tuner if the tuner was last set to the FM band but not if it was last set to the MW/LW band.
- If the tuner was last set to FM, turning on the TA function lets you operate other tuning functions while listening to sources other than tuner.
- Only TP or EON TP stations are tuned in during the Seek Tuning mode when the “TRFC” indicator is ON.
- Only TP or EON TP stations are stored by BSM when the “TRFC” indicator is ON.

■ Canceling Traffic Announcements

- Press the TA button while a traffic announcement is being received to cancel the announcement and return to the original source.



The announcement is canceled but the tuner remains in the TA mode until the TA button is pressed again.

■ Adjusting the TA Volume

When a traffic announcement begins, the volume adjusts automatically to a preset level to enable you to hear the announcement clearly.

- Set the volume by adjusting it during reception of a traffic announcement.

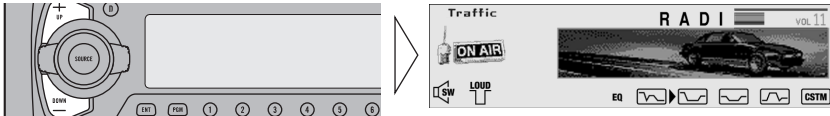

The newly set volume is stored in memory and recalled for subsequent traffic announcements.

■ TP Alarm Function

About 30 seconds after the TP indicator (“”) is extinguished due to a weak signal, a 5 second beep sounds to remind you to select another TP or EON TP station.

- If you are listening to the tuner, tune in another TP station or EON TP station.

In sources other than tuner, the tuner automatically seeks out the TP station with the strongest signal in the current area 10 (or 30)* seconds after the TP indicator (“”) disappears from the display.

* Time taken before Seek begins.

TA function ON	10 seconds
TA, AF functions ON	30 seconds

PTY Function

With Wide and Narrow classification of program type, the PTY function provides two ways to select stations by the type of program being broadcast (PTY Search). It also provides automatic tuning to emergency broadcasts (PTY Alarm).

Note:

- There's no need to perform PTY Search settings again if they have previously been set. After switching to the PTY Search Setting mode in Step 1, just perform PTY Search in Step 4.

■ Searching the PTY

1. Select the PTY Search Setting mode.

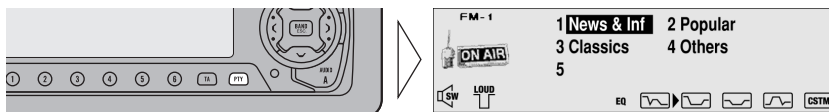

2. Select the PTY Search method (Wide, Narrow).

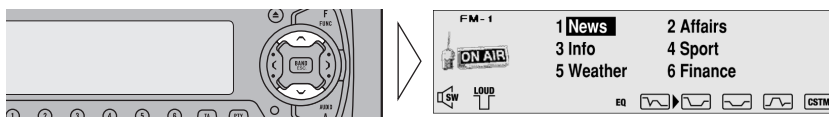

3. Select one from among the PTY.

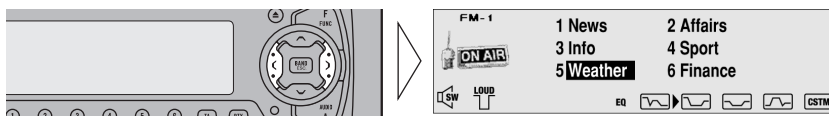

4. Start PTY Search.

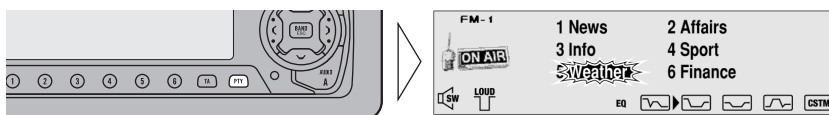

The tuner searches for a station broadcasting the desired PTY.

To cancel the PTY Search Setting mode, hold down the PTY button for 2 seconds.

Note:

- The program of some stations may differ from that indicated by the transmitted PTY.
- If no station broadcasting the selected programming type is found, "NOT FOUND" is displayed for about 2 seconds, and the tuner returns to the original station.

■ News Program Interruption Setting (News)

You can switch automatic reception of PTY code news programs ON/OFF. When a received news program ends, reception of the previous program resumes.

● Set interruption to ON or OFF.

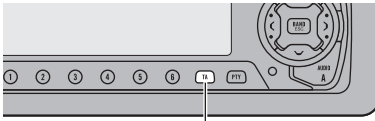

Hold for 2 seconds

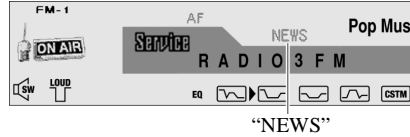

Note:

- You can also switch the News Program Interruption Setting ON/OFF in the Function Menu.

■ PTY Alarm

PTY Alarm is a special PTY code for announcements regarding emergencies such as natural disasters. When the tuner receives the radio alarm code, “ALARM” appears on the display and the volume adjusts to the TA volume. When the station stops broadcasting the emergency announcement, the system returns to the previous source.



Note:

- The system switches back to the original source following emergency announcement reception.

■ Canceling Announcements

- Press the TA button during announcement reception to cancel the announcement and return to the previous source.



■ PTY List

Wide	Narrow	Details
News&Inf	News	News.
	Affairs	Current affairs.
	Info	General information and advice.
	Sport	Sports programs.
	Weather	Weather reports/Meteorological information.
	Finance	Stock market reports, commerce, trading etc.
Popular	Pop Mus	Popular music.
	Rock Mus	Contemporary modern music.
	Easy Mus	Easy listening music.
	Oth Mus	Other types of music, which can't be categorized.
	Jazz	Jazz music based programs.
	Country	Country music based programs.
	Nat Mus	National music based programs.
	Oldies	Oldies music, 'Golden age' based programs.
Classics	Folk Mus	Folk music based programs.
	L. Class	Light classical music.
	Classic	Serious classical music.
Others	Educate	Educational programs.
	Drama	All radio plays and serials.
	Culture	Programs concerned with any aspect of national or regional culture.
	Science	Programs about nature, science and technology.
	Varied	Light entertainment programs.
	Children	Children's programs.
	Social	Social affairs programs.
	Religion	Religion affairs programs or services.
	Phone In	Phone in based programs.
	Touring	Travel programs, not for announcements about traffic problem.
	Leisure	Programs about hobbies and recreational activities.
	Document	Documentary programs.

Using the Built-in CD Player

■ Repeat Play (Play Mode)

Repeat Play plays the same track repeatedly.

1. Press the **FUNCTION** button and select the **Repeat mode (Play Mode)** in the **Function Menu**.
2. Switch the Repeat Play **ON/OFF** with the **▲/▼** buttons.



Note:

- If you perform Track Search or Fast Forward/Reverse, Repeat Play is automatically canceled.

■ Random Play (RandomPlay)

Random Play plays the tracks on a CD in random order for variety.

1. Press the **FUNCTION** button and select the **Random mode (RandomPlay)** in the **Function Menu**.
2. Switch Random Play **ON/OFF** with the **▲/▼** buttons.



■ Scan Play (Scan Play)

Scan Play plays the first 10 seconds or so of each track on an CD in succession.

1. Press the **FUNCTION** button and select the Scan mode (Scan Play) in the **Function Menu**.

2. Switch the Scan Play **ON** with the **▲** button.



3. When you find the desired track, cancel the Scan Play with the **▼** button.



If the Function Menu has been canceled automatically, select the Scan mode in the Function Menu again.

Note:

- Scan Play is canceled automatically after all the tracks on a disc have been scanned.

■ Pause (Pause)

Pause pauses the currently playing track.

1. Press the **FUNCTION** button and select the Pause mode (Pause) in the **Function Menu**.

2. Switch the Pause **ON/OFF** with the **▲/▼** buttons.



■ Selecting Tracks by Track Title List (Track List)

Every 6 track titles on a CD TEXT disc are displayed. You can scroll the display.

1. Press the **FUNCTION** button and select the **Track List mode (Track List)** in the **Function Menu**.

2. Select the desired track title with the **◀/▶** buttons.

“No T.Title” is displayed for track whose titles have not been input.

Note:

- You can also select and play the desired track title directly with the 1 to 6 buttons.

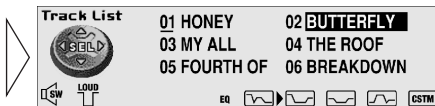

3. Play the selected track with the **▲** button.

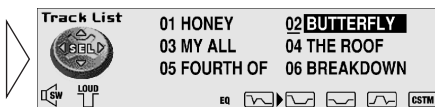

Note:

- When only playing a CD TEXT disc on this product, you can switch to this mode.

■ Disc Title Input (Title Input ABC)

You can input up to 48 disc titles for CDs in the Built-in CD player. (Refer to “Disc Title Input” on page 52 under “Using Multi-CD Players”.)

Note:

- After the title for 48 discs have been entered, data for a new disc will overwrite the oldest one.
- If you connect a Multi-CD player, you can input disc titles for up to 100 discs.
- When playing a CD TEXT disc on this product, you cannot switch to this mode.

■ Repeat Play (Play Mode)

There are three repeat play ranges: One-track Repeat, Disc Repeat and Multi-CD player Repeat. Default repeat play range is Multi-CD player Repeat.

1. Press the FUNCTION button and select the Repeat selecting mode (Play Mode) in the Function Menu.

2. Select the desired repeat play range with the ◀/▶ buttons.

Multi-CD player Repeat (“Magazine Repeat” is displayed) → One-track Repeat (“Track Repeat” is displayed) → Disc Repeat (“Disc Repeat” is displayed)



Note:

- If you select other discs during the repeat play, the repeat play range changes to Multi-CD player Repeat.
- If you perform Track Search or Fast Forward/Reverse during One-track Repeat, the repeat play range changes to Disc Repeat.

■ Random Play (RandomPlay)

Tracks are played at random within the selected repeat mode play range as explained in “Repeat Play” above.

1. Press the FUNCTION button and select the Random mode (RandomPlay) in the Function Menu.

2. Switch the Random Play ON/OFF with the ▲/▼ buttons.

After selecting the desired repeat play range from those referred to in “Repeat Play” above, switch Multi-CD Player Random Play ON.



Note:

- One-track Repeat changes to the Disc Repeat when you switch the Random Play ON.

■ **Scan Play (Scan Play)**

In the Disc Repeat, the beginning of each track on the selected disc is scanned for about 10 seconds. In the Multi-CD player Repeat, the beginning of the first track on each disc is scanned for about 10 seconds.

1. Press the **FUNCTION** button and select the Scan mode (Scan Play) in the **Function Menu**.

2. Switch the Scan Play **ON** with the **▲** button.

After selecting the desired repeat play range from those referred to in “Repeat Play” on page 48, switch Multi-CD Player Scan Play ON.



3. When you find the desired track (or disc), cancel the Scan Play with the **▼** button.

If the Function Menu has been canceled automatically, select the Scan mode in the Function Menu again.



Display	Play range
T. Scan	Disc Repeat
D. Scan	Multi-CD player Repeat

Note:

- Scan Play is canceled automatically after all the tracks or discs have been scanned.
- One-track Repeat changes to the Disc Repeat when you switch the Scan Play ON.

■ **Pause (Pause)**

Pause pauses the currently playing track.

1. Press the **FUNCTION** button and select the Pause mode (Pause) in the **Function Menu**.

2. Switch the Pause **ON/OFF** with the **▲/▼** buttons.



Compression and DBE (Compression)

Using the Comp. (Compression) and DBE (Dynamic Bass Emphasis) functions enables Multi-CD player sound quality adjustment. Each of the functions enables two-step adjustment.

■ Comp.

The Comp. (Compression) function adjusts imbalances between loud and subdued sounds at higher volumes.

■ DBE

DBE (Dynamic Bass Emphasis) boosts bass levels to give a fuller sound.

■ Comp./DBE ON/OFF Switching

1. Press the **FUNCTION** button and select the **Comp./DBE Switching mode (Compression)** in the Function Menu.

2. Select the desired mode with the ▲/▼ buttons.

Comp. OFF → Comp. 1 → Comp. 2 →

Comp. OFF → DBE 1 → DBE 2

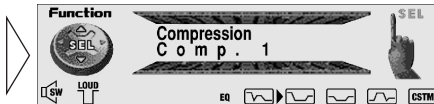

Note:

- You can use these functions with a Multi-CD player that has them. If the player does not feature the Comp./DBE functions, “No Comp.” is displayed if you try to use them.

ITS (Instant Track Selection)

The ITS function allows you to search for the track you wish to play when a Multi-CD player is installed. You can use ITS to program automatic playback of up to 24 tracks per disc from up to 100 discs. (You can store ITS program and Disc Title data for up to 100 discs in memory.)

■ ITS Programming (ITS Memory)

Programmed tracks are played within the selected repeat play range in the “Repeat Play” on page 48.

1. Play the track you wish to program.
2. Select the ITS Programming mode (ITS Memory) in the Detailed Setting Menu. (Refer to page 34.)
3. Program the desired track with the ▲ button.

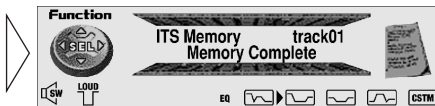

Note:

- After 100 discs have been programmed, data for a new disc will overwrite the data for the disc that has not been played back for the longest time.

■ ITS Play (ITS Play)

ITS Play of tracks is performed within the play range explained in the “Repeat Play” section.

1. Press the FUNCTION button and select the ITS Play mode (ITS Play) in the Function Menu.
2. Switch ITS play ON/OFF with the ▲/▼ buttons.



After selecting the desired repeat play range from those referred to in “Repeat Play” on page 48, switch ITS Play ON.

Note:

- If no track in the current range is programmed for ITS play, “ITS Empty” is displayed.

■ Erase a Track Program

1. Select the track you wish to erase, during ITS Play.
2. Select the ITS Programming mode (ITS Memory) in the Detailed Setting Menu. (Refer to page 34.)
3. Erase the track program with the ▼ button.

ITS is canceled and playback of the next ITS-programmed track begins. If there are no more programmed tracks in the current range, "ITS EMPTY" is displayed and normal play resumes.

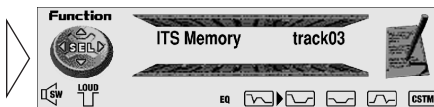

■ Erase a Disc Program

1. Select the disc you wish to erase, while the disc is playing.
2. Select the ITS Programming mode (ITS Memory) in the Detailed Setting Menu. (Refer to page 34.)
3. Erase with the disc program with the ▼ button.

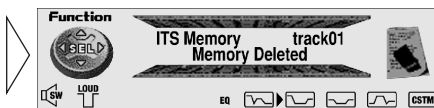

Disc Title

■ Disc Title Input (Title Input ABC)

You can input Titles up to 10 letters long for up to 100 discs. Using this function lets you easily search for and select a desired disc for play. (You can store ITS program and Disc Title data for up to 100 discs in memory.)

1. Play the disc you wish to input the disc title.
2. Select the Disc Title Input mode (Title Input ABC) in the Detailed Setting Menu. (Refer to page 34.)

Note:

- When playing a CD TEXT disc on a CD TEXT compatible Multi-CD player, you cannot switch to this mode.
- A CD TEXT disc is a CD featuring recorded text information such as Disc Title, Artist Name and Track Title.

3. Switch the desired Character type with button 1.

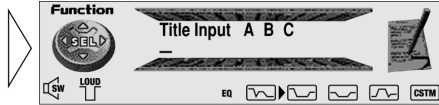

Each press of button 1 changes the Character type in the following order:

Alphabet (Upper case), Numbers and Symbols → Alphabet (Lower case) → European letters, such as those with accents (e.g. á, à, ä, ç)

Note:

- You can select to input Numbers and Symbols by pressing button 2.

4. Select letters, numbers and symbols with the ▲/▼ buttons.

To insert a space, select the flashing cursor “_”.

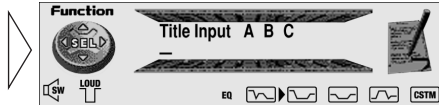

5. Move the box left and right with the ◀/▶ buttons.

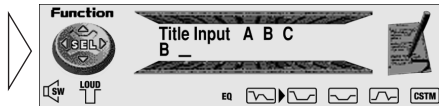

6. When you have completed title input, make the 10th letter flash, then memorize by pressing the ► button.



Note:

- Titles remain in memory, even after the disc has been removed from the magazine, and are recalled when the disc is reinserted.
- After the titles for 100 discs have been entered, data for a new disc will overwrite the data for the disc that has not been played back for the longest time.
- You can display the disc title of the disc currently playing. For details, refer to “Switching the Display” on page 26.

■ Selecting Discs by Disc Title List (Disc List)

Every 6 discs are displayed. You can scroll the display.

Follow the procedures below to play a disc for which you have input the title in a Multi-CD player or a CD TEXT disc on a CD TEXT compatible Multi-CD player.

1. Press the **FUNCTION** button and select the **Disc Title List mode (Disc List)** in the **Function Menu**.

2. Select the desired disc title with the **◀/▶** buttons.

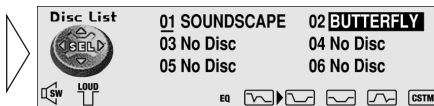

“No D.Title” is displayed for disc whose titles have not been input.

“No Disc” is displayed next to the disc number when no disc is set in the magazine.

Note:

- You can also select and play the desired disc title directly with the 1 to 6 buttons.

3. Play the selected disc with the **▲** button.

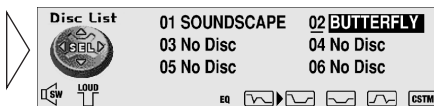

■ Selecting Tracks by Track Title List (Track List)

Every 6 tracks on a CD TEXT disc are displayed. You can scroll the display.

1. Press the **FUNCTION** button and select the **Track List mode (Track List)** in the **Function Menu**.

Note:

- When only playing a CD TEXT disc on a CD TEXT compatible Multi-CD player, you can switch to this mode.

2. Select the desired track title with the **◀/▶** buttons.

“No T.Title” is displayed for track whose titles have not been input.

Note:

- You can also select and play the desired track title directly with the 1 to 6 buttons.

3. Play the selected track with the **▲** button.

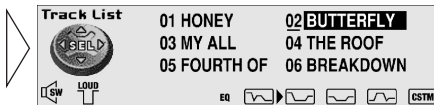

Selecting the Equalizer Curve

You can switch between Equalizer curves.

- Rotate the EQ selector up or down to select the desired Equalizer curve.

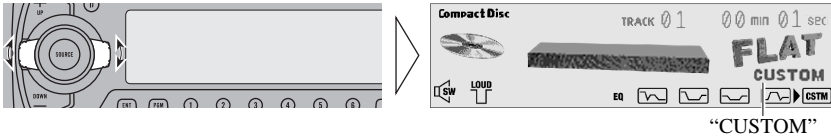

SUPER BASS ↔ POWERFUL ↔ NATURAL ↔ VOCAL ↔ CUSTOM ↔ FLAT

Note:

- “CUSTOM” stores an equalizer curve you have made adjustments to. (Refer to “Equalizer Curve Adjustment” on page 57 and “Equalizer Curve Fine Adjustment” on page 58.)
- You can create different “CUSTOM” curves for different sources. (The Built-in CD player and Multi-CD player are set to the same Equalizer Curve Adjustment setting automatically.)
- When “CUSTOM” is selected, the displayed curve and name switches to that selected before adjustments were made (refer to pages 57 to 58) and “CUSTOM” is also displayed. Initially, “FLAT” and “CUSTOM” appear on the display.

Entering the Audio Menu

With this Menu, you can adjust the sound quality.

Note:

- After entering the Audio Menu, if you do not perform an operation within about 30 seconds, the Audio Menu is automatically canceled.
- Audio Menu functions change depending on the Rear Speaker Output and Subwoofer Controller setting in the Initial Setting Menu. (Refer to “Switching the Rear Speaker Output” and “Setting the Subwoofer Control” on page 68.)

1. Select the desired mode in the Audio Menu.

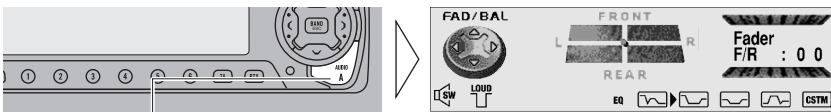

Each press changes the Mode ...

2. Operate a mode.

3. Cancel the Audio Menu.

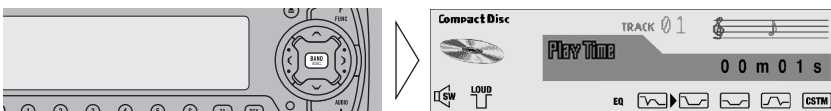

Audio Menu Functions

The Audio Menu features the following functions.

■ **Balance Adjustment (FAD/BAL)**

This function allows you to select a Fader/Balance setting that provides ideal listening conditions in all occupied seats.

1. Press the **AUDIO** button and select the **Fader/Balance mode (FAD/BAL)** in the **Audio Menu**.

2. Adjust front/rear speaker balance with the **▲/▼** buttons.

“Fader Front:15” – “Fader Rear:15” is displayed as it moves from front to rear.

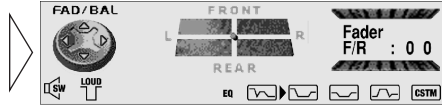

3. Adjust left/right speaker balance with the **◀/▶** buttons.

“Balance Left:9” – “Balance Right:9” is displayed as it moves from left to right.

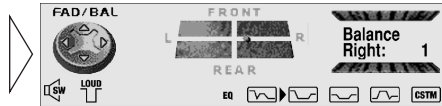

Note:

- When the Rear Speaker Output setting is “Sub woofer output”, you cannot adjust front/rear speaker balance. (Refer to page 68.)
- “Fader F/R:0 0” is the proper setting when 2 speakers are in use.

■ Equalizer Curve Adjustment (Equalizer)

You can adjust the currently selected equalizer settings as desired. Adjusted equalizer curve settings are memorized in “CUSTOM”.

1. Press the **AUDIO** button and select the **Equalizer mode (Equalizer)** in the Audio Menu.

2. Select the band you want to adjust with the ◀/▶ buttons.

LOW BAND ↔ MID BAND ↔
HIGH BAND

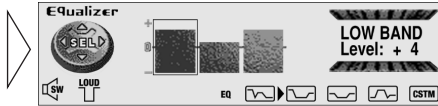

3. Boost or attenuate the selected band with the ▲/▼ buttons.

The display shows “+6” – “-6”.

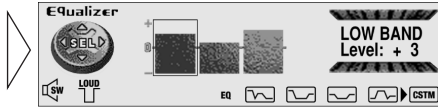

Note:

- If you make adjustments when a curve other than “CUSTOM” is selected, the newly adjusted curve will replace the previous adjusted curve. And new curve and name with “CUSTOM” appear on the display while selecting the equalizer curve. (Refer to page 55.)

■ Equalizer Curve Fine Adjustment (Equalizer)

You can adjust the center frequency and the Q factor (curve characteristics) of each currently selected curve band (LOW BAND/MID BAND/HIGH BAND). Adjusted equalizer curve settings are memorized in “CUSTOM”.

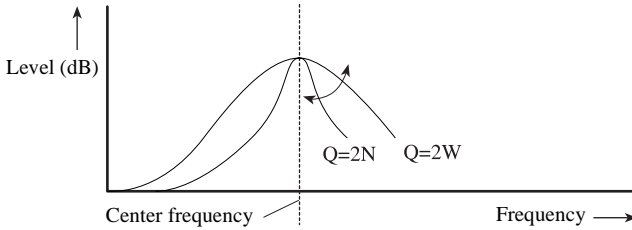

1. Press the **AUDIO** button for 2 seconds to select Equalizer Curve Fine Adjustment.

2. Press the **AUDIO** button to select the desired band for adjustment.

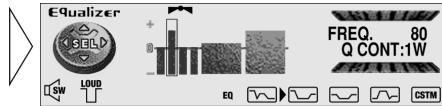

3. Select the desired frequency for each band with the **◀/▶** buttons.

LOW: 40 ↔ 80 ↔ 100 ↔ 160 (Hz)
 MID: 200 ↔ 500 ↔ 1k ↔ 2k (Hz)
 HIGH: 3.15k ↔ 8k ↔ 10k ↔ 12.5k (Hz)

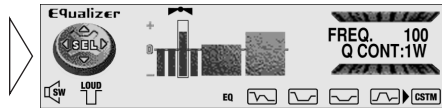

4. Select the desired Q factor with the **▲/▼** buttons.

2N ↔ 1N ↔ 1W ↔ 2W

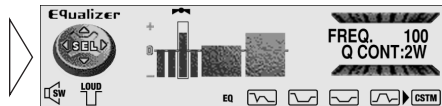

Note:

- If you make adjustments when a curve other than “CUSTOM” is selected, the newly adjusted curve will replace the previous adjusted curve. A new curve and name with “CUSTOM” appears on the display while selecting the equalizer curve. (Refer to page 55.)

■ Loudness Adjustment (Loudness)

The Loudness function compensates for deficiencies in the low and high sound ranges at low volume. You can select a desired Loudness level.

1. Press the **AUDIO** button and select the Loudness mode (Loudness) in the Audio Menu.

2. Switch the Loudness function ON/OFF with the ▲/▼ buttons.

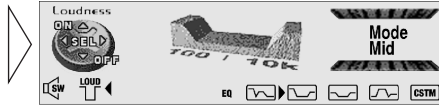

3. Select the desired level with the ◀/▶ buttons.

Low ↔ Mid ↔ High

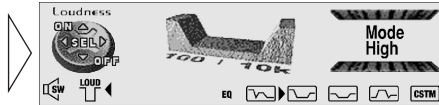

■ Subwoofer Output (Sub W-1)

When a Subwoofer is connected, switch Subwoofer output ON.

Initially, Subwoofer output is OFF.

The Subwoofer output phase can be switched between normal, or 0° (“Phase:NOR”), and reverse, or 180° (“Phase:REV”). 0° is the default phase.

Note:

- When the Subwoofer Controller setting is “Sub woofer control External”, you cannot switch the Subwoofer ON/OFF mode. In this case, this setting is not necessary. (Refer to page 68.)
- Select the OFF setting when you do not want the Subwoofer to operate.

1. Press the **AUDIO** button and select the Subwoofer ON/OFF mode (Sub W-1) in the Audio Menu.

2. Switch the Subwoofer output ON/OFF with the ▲/▼ buttons.



3. Change the phase of Subwoofer output with the ◀/▶ buttons.



■ Subwoofer Setting Adjustment (Sub W-2)

When the Subwoofer output is ON, you can adjust the cut-off frequency and the output level of Subwoofer.

1. Press the **AUDIO** button and select the Subwoofer setting mode (Sub W-2) in the Audio Menu.
2. Select the frequency to 50 Hz, 80 Hz or 125 Hz with the ◀/▶ buttons.



3. Increase or decrease the output level with the ▲/▼ buttons.

The display shows “+6” – “-6”.



Note:

- You can select the Subwoofer setting mode only when Subwoofer output is switched ON in the Subwoofer ON/OFF mode.

■ Non-Fading Output (Non Fade-1)

When the Non-Fading Output setting is ON, the audio signal does not pass through this unit's low pass filter (for the Subwoofer), but is output through the RCA output.

Note:

- When the Subwoofer Controller setting is only “Sub woofer control External”, you can switch the Non-Fading Output ON/OFF mode. (Refer to page 68.)

1. Press the **AUDIO** button and select the Non-Fading Output ON/OFF mode (Non Fade-1) in the Audio Menu.
2. Switch the Non-Fading output ON/OFF with the ▲/▼ buttons.



■ Non-Fading Output Level Adjustment (Non FaDE-2)

When the Non-Fading output is ON, you can adjust the level of Non-Fading output.

1. Press the **AUDIO** button and select the **Non-Fading Output setting mode (Non FaDE-2)** in the Audio Menu.
2. Increase or decrease the level with the **▲/▼** buttons.

The display shows “0” – “-15”.

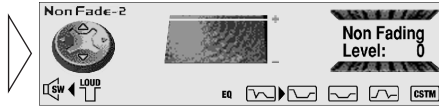

Note:

- You can select the Non Fading Output setting mode only when Non Fading Output is switched ON in the Non Fading Output ON/OFF mode.

■ High Pass Filter (High Pass)

When you do not want sound in the Subwoofer output frequency range output from the front or rear speakers, switch the High Pass Filter ON. Only higher frequencies than those in the selected range are output from the front and rear speakers.

Precaution:

- Do not switch F.I.E. function and High Pass Filter function ON at the same time.

1. Press the **AUDIO** button and select the **High Pass Filter mode (High Pass)** in the Audio Menu.
2. Switch the High Pass Filter function ON/OFF with the **▲/▼** buttons.

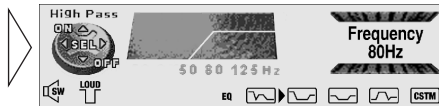

3. Select the desired frequency with the **◀/▶** buttons.

50 ↔ 80 ↔ 125 (Hz)

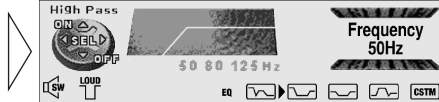

■ Front Image Enhancer Function (FIE)

The F.I.E. (Front Image Enhancer) function is a simple method of enhancing front imaging by cutting mid- and high-range frequency output from the rear speakers, limiting their output to low-range frequencies. You can select the frequency you want to cut.

Precaution:

- Do not switch F.I.E. function and High Pass Filter function ON at the same time.
- When the F.I.E. function is deactivated, the rear speakers output sound of all frequencies, not just bass sounds. Reduce the volume before disengaging F.I.E. to prevent a sudden increase in volume.

1. Press the **AUDIO** button and select the **F.I.E. mode (FIE)** in the Audio Menu.

2. Switch the **F.I.E. function ON/OFF** with the **▲/▼** buttons.



3. Select the desired frequency with the **◀/▶** buttons.

100 ↔ 160 ↔ 250 (Hz)

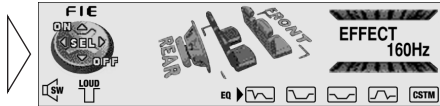

Note:

- After switching the F.I.E. function ON, select the Fader/Balance mode in the Audio Menu, and adjust front and rear speaker volume levels until they are balanced.
- When the Rear Speaker Output setting is “Sub woofer output”, you cannot switch the F.I.E. mode. (Refer to page 68.)
- Switch the F.I.E. function OFF when using a 2-speaker system.

■ **Source Level Adjustment (SLA) Function**

The SLA (Source Level Adjustment) function prevents radical leaps in volume level when switching between sources. Settings are based on the FM volume level, which remains unchanged.

- 1. Compare the FM volume with the volume of the other source.
(e.g. Built-in CD player)**
- 2. Press the AUDIO button and select the SLA mode (SLA) in the Audio Menu.**
- 3. Increase or decrease the level with the ▲/▼ buttons.**

The display shows “+4” – “-4”.

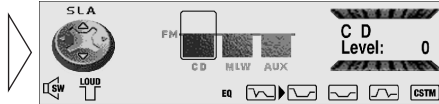

Note:

- Since the FM volume is the control, SLA is not possible in the FM modes.
- The MW/LW volume level, which is different from the FM base setting volume level, can also be adjusted similar to sources other than tuner.
- The Built-in CD player and Multi-CD player are set to the same volume adjustment setting automatically.

Theft Protection

The front panel of the head unit is detachable to discourage theft.

Precaution:

- Never use force or grip the display tightly when removing or replacing the front panel.
- Avoid subjecting the front panel to excessive shocks.
- Keep the front panel out of direct sunlight and high temperatures.

■ Detaching the Front Panel

1. Open the front panel.

Precaution:

- A few seconds after turning the ignition switch to ON/OFF, the front panel automatically moves. When this happens, your fingers may become jammed in the panel, so keep your hands away from it.

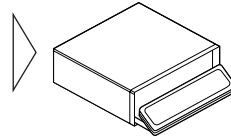

2. Slide and remove the front panel toward you.

Take care not to grip the front panel tightly or drop it.

Precaution:

- When removing the front panel, be sure to press the corrugated release section on the rear of the front panel while pulling.

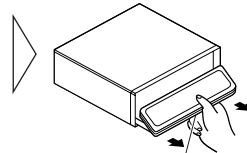

Release Section

3. Use the protective case provided to store/carry the detached front panel.

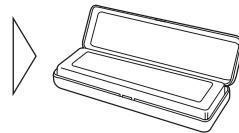

■ Replacing the Front Panel

1. Make sure the inner cover is closed.

2. Replace the front panel by clipping it into place.

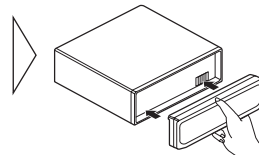

■ Warning Tone

If the front panel is not detached within 5 seconds after the ignition is turned off, a warning tone will sound.

Note:

- You can cancel the warning tone function. (Refer to page 67.)

Entering the Initial Setting Menu

With this menu, you can perform initial settings for the product.

1. Turn the source OFF.
2. Enter the Initial Setting Menu.



Hold for 2 seconds

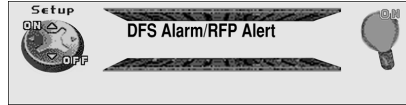

3. Select the desired mode.



Each press changes the Mode ...



4. Operate a mode.
5. Cancel the Initial Setting Menu.

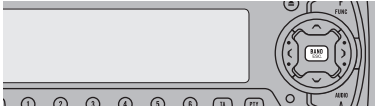

Note:

- ALARM is a new feature of the “Removable Front Panel Alert”. Refer to “RFP Alert Function” for details and instructions on how to use this function.
- Holding down the FUNCTION button for 2 seconds also cancels the Initial Setting Menu.

Initial Setting Menu Functions

The Initial Setting Menu features the following functions.

■ **Changing the FM Tuning Step (FM tuning step)**

Normally set at 50 kHz during Seek tuning in the FM mode, the tuning step changes to 100 kHz when the AF or TA mode is activated.

It may be preferable to set tuning step to 50 kHz in the AF mode.

1. Press the **FUNCTION** button and select the **FM Tuning Step mode (FM tuning step)** in the Initial Setting Menu.

2. Select the desired tuning step with the **◀/▶** buttons.



Note:

- The tuning step remains set at 50 kHz during Manual tuning.
- The tuning step returns to 100 kHz if the battery is temporarily disconnected.

■ **Setting the DAB Priority Function (DAB Priority)**

When a Hide-away DAB tuner (e.g. GEX-P900DABII) is connected, you can set the product in this mode so that the interruption of traffic information from the Hide-away DAB tuner takes precedence over this product's RDS Traffic Announcement (TA) function.

■ **When it is ON**

During DAB reception, when the selected Service Component supports Road Traffic Flashes and Transport Flashes, reception is not interrupted by this product's RDS Traffic Announcement (TA).

■ **When it is OFF**

Interruption is by the first received news flash from among this product's RDS and the hide-away DAB traffic information broadcasts.

1. Press the **FUNCTION** button and select the **DAB Priority Setting mode (DAB Priority)** in the Initial Setting Menu.

2. Switch the DAB Priority Setting **ON/OFF** with the **▲/▼** buttons.

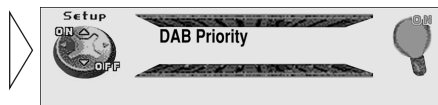

Note:

- You can only select to the DAB Priority Setting mode when a separately sold Hide-away DAB tuner (e.g. GEX-P900DABII) is connected.

■ Switching the Auto PI Seek (Auto PI Seek)

During Preset Station PI Seek operation, you can switch the Auto PI Seek function ON/OFF. (Refer to “PI Seek Function” on page 39.)

1. Press the **FUNCTION** button and select the **Auto PI Seek mode (Auto PI Seek)** in the **Initial Setting Menu**.
2. Switch the **Auto PI Seek ON/OFF** with the **▲/▼** buttons.

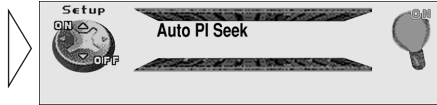

■ Setting the Warning Tone (Warning Tone)

You can switch the Warning Tone function ON/OFF. (Refer to “Warning Tone” on page 64.)

1. Press the **FUNCTION** button and select the **Warning Tone mode (Warning Tone)** in the **Initial Setting Menu**.
2. Switch the **Warning Tone ON/OFF** with the **▲/▼** buttons.

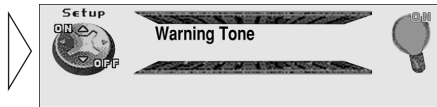

■ Switching the AUX Mode (AUX)

It is possible to use auxiliary (AUX) equipment with this product. Activate the AUX mode when using external equipment with this product.

1. Press the **FUNCTION** button and select the **AUX Setting mode (AUX)** in the **Initial Setting Menu**.
2. Switch the **AUX ON/OFF** with the **▲/▼** buttons.



■ Switching the Rear Speaker Output (Rear Speaker Out)

This product's rear speaker leads can be used for full-range speaker ("Full Range output") or Subwoofer ("Sub woofer output") connection. If you switch Rear Speaker Lead setting to the "Sub woofer output", you can connect a rear speaker lead directly to a Subwoofer without using an auxiliary amp.

1. Press the **FUNCTION** button and select the **Rear Speaker Output mode (Rear Speaker Out)** in the **Initial Setting Menu**.

2. Select the desired **Rear Speaker Out** with the **▲/▼** buttons.



Note:

- When no Subwoofer is connected to the rear speaker lead, select "Full Range output".
- Even if you change to "Sub woofer output", there is no output unless you switch the Subwoofer Output (refer to page 59) in the Audio Menu ON.

■ Setting the Subwoofer Control (Sub woofer control)

When rear speaker leads are connected to full range speakers (when "Full Range output" is selected), you can connect the RCA Subwoofer output to a Subwoofer. In this case, you can select whether to use the Subwoofer controller's (Low Pass Filter, Phase) built-in "Internal" or the auxiliary "External".

1. Press the **FUNCTION** button and select the **Subwoofer Control mode (Sub woofer control)** in the **Initial Setting Menu**.

2. Change the **Subwoofer Controller** with the **◀/▶** buttons.

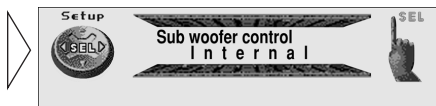

Note:

- When the Rear Speaker Output is "Sub woofer output", you cannot change the Subwoofer Controller.
- If you change the Subwoofer Controller, Subwoofer output and Non-Fading output in the Audio Menu return to the factory settings.
- Even if you change this setting, there is no output unless you switch the Non-Fading Output (refer to page 60) or Subwoofer Output (refer to page 59) in the Audio Menu ON.

■ Setting the Dimmer (Dimmer)

To enable this product's display from being too bright at night, when the vehicle's head lights are turned ON the display is dimmed.

You can switch this function ON/OFF.

1. Press the **FUNCTION** button and select the **Dimmer mode (Dimmer)** in the **Initial Setting Menu**.
2. Switch the **Dimmer ON/OFF** with the **▲/▼** buttons.



■ Selecting the Illumination Color (Illumination Color)

This product is equipped with two illumination colors, green and red.

You can select the desired illumination color.

1. Press the **FUNCTION** button and select the **Illumination Color mode (Illumination Color)** in the **Initial Setting Menu**.
2. Select the desired illumination color with the **◀/▶** buttons.



■ Selecting the Wall Paper (Wall Paper)

This product is equipped with three types of wall paper.

1. Press the **FUNCTION** button and select the **Wall Paper mode (Wall Paper)** in the **Initial Setting Menu**.
2. Select the desired **Wall Paper** with the **◀/▶** buttons.

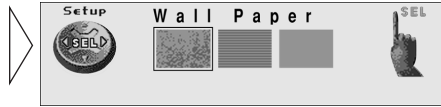

■ Selecting the Brightness (Brightness)

You can select the display brightness. The display shows “0” – “31”.

1. Press the **FUNCTION** button and select the **Brightness mode (Brightness)** in the **Initial Setting Menu**.
2. Select the desired **Brightness** with the **◀/▶** buttons.

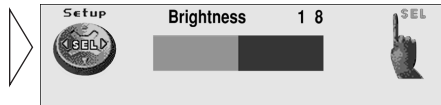

RFP Alert Function

In addition to the Removable Front Panel, Pioneer has incorporated a new feature “**Removable Front Panel Alert**”. This feature is designed to protect your new Pioneer car stereo as well as your vehicle contents.

Activating the RFP Alert Feature

Pioneer has developed a menu display that allows you to set-up your RFP Alert to meet your personal needs. By scrolling through this menu it is possible to select your own “Entry Delay Time”, “Speaker Output Volume” and “Door System Type”.

Initially from the factory the RFP Alert feature is not activated.

1. Select the RFP Alert Feature **ON/OFF** mode (DFS Alarm/RFP Alert) in the Initial Setting Menu. (Refer to page 65.)

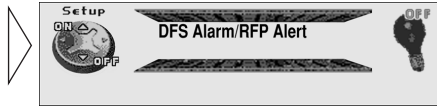

2. Press the **▲** button to switch the RFP Alert Feature **ON**.

Press the **▼** button to deactivate the RFP Alert Feature.



3. Press the **FUNCTION** button for 2 seconds to enter the RFP Alert Setting Menu.



Setting Entry Delay Time

Initially the “Entry Delay Time” is set to 15 seconds. The “Entry Delay Time” can be adjusted to be 0, 5, 15, 30, 45 or 60 seconds.

1. Decrease or increase the “Entry Delay Time” with the **◀/▶** buttons.



2. Press the **FUNCTION** button to move to the next selection.



Activating Internal Speaker ON/OFF

This feature allows you to select whether or not the speaker output is sounded when the “RFP Alert” is triggered. Initially from the factory the speaker output is activated. Toggling between ▲, ▼ buttons allows you to deactivate or activate the “Speaker Output”. If you switch the speaker output OFF, you cannot change the “Test Mode”.

■ Speaker Volume Output Adjustment

If the “Speaker Output” has been selected then it is possible to adjust the volume of the speaker output for when the Alert is triggered. To adjust the volume you must engage the “Test Mode”.

Note:

- If the “Speaker Output” is turned OFF, then this menu will not appear.

1. Select the “Test Mode” with the ► button.



2. Press the ▲ button to switch the “Test Mode” ON.

In this mode the speakers will sound.

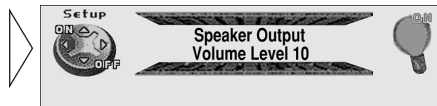

3. Decrease or increase the volume with the +/- button.

Display shows “10” – “40”.

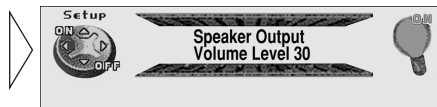

4. After setting volume, switch the “Test Mode” OFF with the ▼ button.

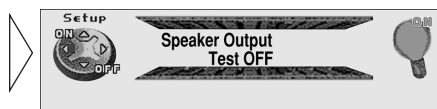

5. Cancel the “Test Mode” with the ◀ button.



6. Press the FUNCTION button to move to the next selection.

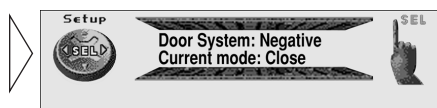

Selecting Door Switching Systems

It is necessary to select the correct “Door System Type” (Negative or Positive switching) for that of your vehicle. Initially, the system is set for vehicles with the grounding type (Negative switching).

Select the correct “Door System Type” of your vehicle from below.

■ **Vehicles to select “Door System: Negative, Current mode: Close”**

EUROPEAN, JAPANESE, GM, CHRYSLER

■ **Vehicles to select “Door System: Positive, Current mode: Close”**

JAGUAR, MERCEDES*, FORD, etc.

* Some Models Only.

- **Select “Door System: Negative” or “Door System: Positive” with the ◀/▶ buttons.**

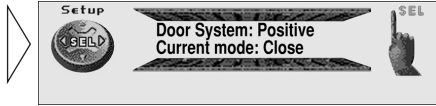

■ **Door System Confirmation**

The door system confirmation feature was incorporated to ensure that the correct door system type has been selected. (e.g. Set to “Door System: Positive” for JAGUAR vehicles.)

1. **First, close all the vehicle's doors. If the correct door system type has been selected then the Display will show “Current mode: Close”.**

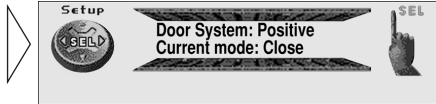

If not, select the alternative door system type by pressing the ◀ or ▶ button. Lastly, confirm each door triggers the Alert by opening and closing each vehicle’s door.

2. **As the vehicle's door is opened the display should change accordingly (“Current mode: Close” – “Current mode: Open”).**

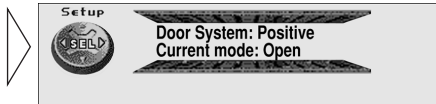

3. Press the BAND button and cancel the RFP Alert Setting Menu.

Setting of the “RFP Alert” is now complete.

Note:

- In case that the battery is disconnected or the RESET button is pressed, it may be necessary to reprogram the RFP Alert Menu, otherwise this setting needs to be done only once.
- When the RFP Alert is armed, you cannot disarm it by pressing the RESET button.



Operation of “RFP Alert”

Providing the installation and setting of the “RFP Alert Setting Menu” has been performed correctly, operation of the “RFP Alert” is very simple.

Arming Alert

To arm your Alert simply turn off the ignition and detach the front panel, as described on page 64. After detaching the front panel the “RFP Alert” will automatically arm itself after 30 seconds, providing all of the doors are closed. If after 30 seconds, a door still remains open the RFP Alert will not arm until the last door has been closed. After closing all of the doors, ensure that they are securely locked. The LED indicator on the head unit will flash as a visual deterrent. Your vehicle is now protected by your “RFP Alert”.

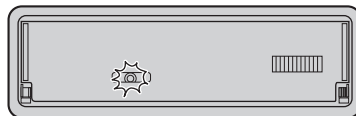
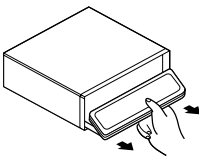

Disarming Alert

Upon entering your vehicle, and within the “Entry Delay Time” set within the “RFP Alert Menu”, attach your Pioneer Front Panel as described on page 64.

If you have forgotten your removable front panel, simply insert the ignition key in the ignition and turn the key from “OFF” to “ON” within the “Entry Delay Time”.

Entry Detection

If the “RFP Alert” was not disarmed in accordance with “Disarming Alert”, the “RFP Alert” will be triggered. The “RFP Alert” will sound for 60 seconds and will repeat 5 times if any door is left open or reopened. After the fifth time the “RFP Alert” will reset to prevent continuous sounding and prevent your battery from discharging.

Precaution:

- Upon returning to your vehicle and before opening any doors, check to see if the LED indicator is still flashing. If the LED is no longer flashing, it indicates that the Alert has sounded. Disarming, as described above, is still necessary.

Switching the Entertainment Display

You can change the display to the movie screens, etc. while listening to each source.
(e.g. MOVIE SCREEN MODE 1)

- **Select the desired Entertainment Display.**

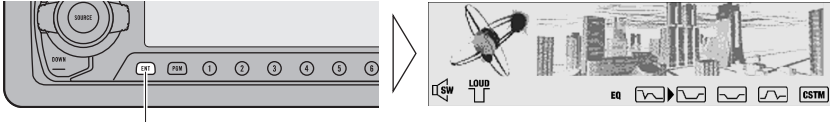

Each press changes the Display ...

Each press of the ENTERTAINMENT button changes the display in the following order:
LEVEL INDICATOR → MOVIE SCREEN MODE 1 → MOVIE SCREEN MODE 2
→ Display before entering the Entertainment Display

Using the PGM Button (Program Function)

The PGM button can memorize one of the functions in the Function Menu.
It is possible to memorize a different function for each source.

- **Setting the PGM Button**

1. **Select the PGM button's setting mode (Program Function) in the Detailed Setting Menu. (Refer to page 34.)**

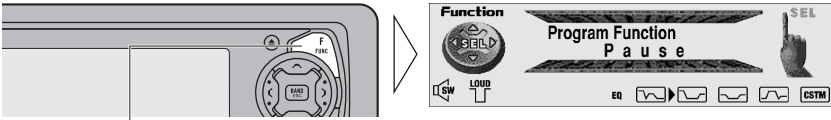

Hold for 2 seconds

2. **Select the function you want to memorize in the PGM button.**

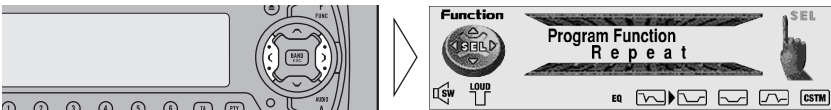

3. **Memorize the function in PGM button.**

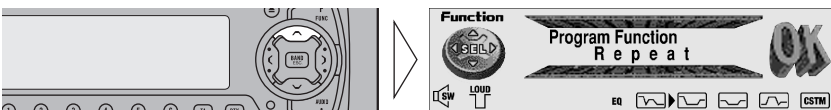

Pressing the BAND button cancels the Detailed Setting Menu.

■ Using the PGM Button

The PGM button operates in a different way depending on the function programmed (memorized).

● Use the PGM button.



■ Tuner

Function Name (Display)	Press	Hold for 2 seconds
Best Stations Memory (BSM)	OFF	ON
Regional Function (Regional)	ON/OFF	———
Local Seek Tuning (Local)	ON/OFF	Entering the Local Seek Sensitivity mode

■ Built-in CD Player

Function Name (Display)	Press	Hold for 2 seconds
Pause (Pause)	ON/OFF	———
Repeat Play (Repeat)	ON/OFF	———
Random Play (Random)	ON/OFF	———

■ Multi-CD Player

Function Name (Display)	Press	Hold for 2 seconds
Pause (Pause)	ON/OFF	———
Repeat Play (Repeat)	Selecting the mode	———
Random Play (Random)	ON/OFF	———
Disc List (List)	Enter the LIST mode	———
ITS (ITS)	ITS Memory	ON/OFF

Using the AUX Source

It is possible to use auxiliary (AUX) equipment with this product.

To listen to auxiliary equipment, switch the AUX Mode in the Initial Setting Menu ON, and then select the desired source.

■ Selecting the AUX Source

- **Select AUX. (Refer to page 24.)**



Each press changes the Source ...

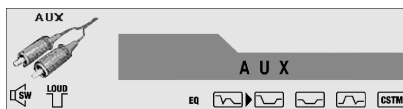

■ AUX Title Input

The display title for AUX Source can be changed.

1. **Select the Aux Title Input mode (Title Input ABC) in the Detailed Setting Menu.**

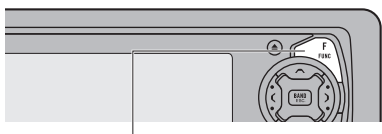

Hold for 2 seconds



2. **Input the Aux Title.**

Refer to “Disc Title Input” on page 52, and perform procedures 3 to 6 in the same way.

Cellular Telephone Muting

Sound from this system is muted automatically when a call is made or received using a cellular telephone connected to this product.

- The sound is turned off, “MUTE” is displayed and no audio adjustment is possible. Operation returns to normal when the phone connection is ended.



Precaution

- Play only CDs bearing the Compact Disc Digital Audio mark. (If a CD features the top right mark on its disc title side, that disc is a CD TEXT disc. There are also some CD TEXT discs that do not feature the top right mark.)



- This product is designed for use with conventional, fully circular CDs only. Use of shaped CDs are not recommended for this product.

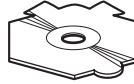

- Check all CDs before playing and discard cracked, scratched or warped discs.
- Playback by this product of a CD-R disc recorded on a CD recorder may not be possible due to characteristics of the disc, scratches or dirt on the disc, or dirt or condensation on this product's optical pickup lens.
- Read the precautions with the CD-R discs before using.
- Wipe dirty or damp discs outward from the center with a soft cloth.
- Avoid touching the recorded (iridescent) surface when handling discs.
- Store discs in their cases when not in use.
- Keep discs out of direct sunlight and high temperatures.
- Do not affix labels or apply chemicals to discs.
- Condensation may collect inside the player when using the heater in cold weather, interfering with playback. Turn it off for an hour or so and wipe damp discs with a soft cloth.
- Road shocks may interrupt CD playback.

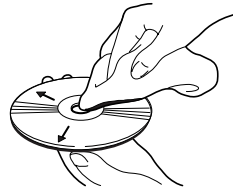

Built-in CD Player's Error Message

When problems occur with CD playback, an error message appears on the display. Refer to the table below to identify the problem, then take the suggested corrective action. If the error persists, contact your dealer or your nearest PIONEER Service Center.

Message	Possible cause	Recommended action
ERROR- 11, 12, 17, 30	Dirty disc.	Clean the disc.
ERROR- 11, 12, 17, 30	Scratched disc.	Replace the disc.
ERROR- 14	Unrecorded CD.	Check the disc.
ERROR- 10, 11, 12, 14, 17, 30, A0	Electrical or mechanical problem.	Turn the ignition ON and OFF, or switch to a different source, then back to the CD player.
HEAT	CD player overheating.	Discontinue play until the machine temperature drops.

General

Power source	14.4 V DC (10.8 – 15.1 V allowable)
Grounding system	Negative type
Max. current consumption	10.0 A
Dimensions	
(mounting size)	178 (W) × 50 (H) × 157 (D) mm
(front face)	188 (W) × 58 (H) × 20 (D) mm
Weight	1.8 kg

Audio

Maximum power output	45 W × 4
	45 W × 2 ch/4 Ω + 70 W × 1 ch/2 Ω (for Subwoofer)
Continuous power output	27 W × 4
	(DIN45324, +B = 14.4 V)
Load impedance	4Ω (4–8Ω [2Ω for 1 ch] allowable)
Preout maximum output	
level/output impedance	4.0 V/100Ω
Equalizer (3-Band Parametric Equalizer)	
(Low)	Frequency: 40/80/100/160 Hz
	Q Factor: 0.35/0.59/0.95/1.15
	(+6 dB when boosted)
	Gain: ±12 dB
(Mid)	Frequency: 200/500/1k/2k Hz
	Q Factor: 0.35/0.59/0.95/1.15
	(+6 dB when boosted)
	Gain: ±12 dB
(High)	Frequency: 3.15k/8k/10k/12.5k Hz
	Q Factor: 0.35/0.59/0.95/1.15
	(+6 dB when boosted)
	Gain: ±12 dB
Loudness contour	
(Low)	+3.5 dB (100 Hz), +3 dB (10 kHz)
(Mid)	+10 dB (100 Hz), +6.5 dB (10 kHz)
(High)	+11 dB (100 Hz), +11 dB (10 kHz)
	(volume: –30 dB)

HPF

Frequency	50/80/125 Hz
Slope	–12 dB/oct.

Subwoofer output

Frequency	50/80/125 Hz
Slope	–18 dB/oct.
Gain	±12 dB
Phase	Normal/Reverse

CD player

System	Compact disc audio system
Usable discs	Compact disc
Signal format	Sampling frequency: 44.1 kHz
	Number of quantization bits: 16; linear
Frequency characteristics	5 – 20,000 Hz (±1 dB)
Signal-to-noise ratio	95 dB (1 kHz) (IEC-A network)
Dynamic range	94 dB (1 kHz)
Number of channels	2 (stereo)

FM tuner

Frequency range	87.5 – 108 MHz
Usable sensitivity	11 dBf
	(1.0 μV/75 Ω, mono, S/N: 30 dB)
50 dB quieting sensitivity	16 dBf
	(1.7 μV/75 Ω, mono)
Signal-to-noise ratio	70 dB (IEC-A network)
Distortion	0.3% (at 65 dBf, 1 kHz, stereo)
Frequency response	30 – 15,000 Hz (±3 dB)
Stereo separation	40 dB (at 65 dBf, 1 kHz)

MW tuner

Frequency range	531 – 1,602 kHz (9 kHz)
Usable sensitivity	18 μV (S/N: 20 dB)
Selectivity	50 dB (±9 kHz)

LW tuner

Frequency range	153 – 281 kHz
Usable sensitivity	30 μV (S/N: 20 dB)
Selectivity	50 dB (±9 kHz)

Note:

- Specifications and the design are subject to possible modification without notice due to improvements.

France: tapez 36 15 PIONEER

PIONEER ELECTRONIC CORPORATION

1-4, MEGURO 1-CHOME, MEGURO-KU, TOKYO 153-8654, JAPAN

PIONEER ELECTRONICS (USA) INC.

P.O. Box 1760, Long Beach, California 90801, U.S.A.

TEL: (800) 421-1404

PIONEER ELECTRONIC (EUROPE) N.V.

Haven 1087 Keetberglaan 1, 9120 Melsele, Belgium

TEL: (0) 3/570.05.11

PIONEER ELECTRONICS AUSTRALIA PTY. LTD.

178-184 Boundary Road, Braeside, Victoria 3195, Australia

TEL: (03) 9586-6300

PIONEER ELECTRONICS OF CANADA, INC.

300 Allstate Parkway, Markham, Ontario L3R 0P2, Canada

TEL: (905) 479-4411

PIONEER ELECTRONICS DE MEXICO, S.A. de C.V.

San Lorenzo Num 1009 3er piso Desp. 302

Col. Del Valle, Mexico D.F. C.P. 03100

TEL: 5-688-52-90

Published by Pioneer Electronic Corporation. Copyright © 1999 by Pioneer Electronic Corporation. All rights reserved.

Printed in Belgium

MAN-DEH-P8100R-GB/B